

**MWM1000N**

**WASHING MACHINE  
USER MANUAL**



## **THE CONTENTS**

### **SECTION 1:BEFORE USING**

- Safety warnings
- Recommendations

### **SECTION 2:INSTALLATION**

- Removal of transportation screws
- Adjustment of feet
- Electrical connection
- Water supply connection
- Water drain connection

### **SECTION 3: GETTING TO KNOW YOUR WASHING MACHINE**

#### **SECTION 4:CONTROL PANEL**

- Start/Pause button
- Function indicator lights
- Function buttons
- Program knob

#### **SECTION 5:WASHING YOUR LAUNDRY**

- Before washing
- Running the machine

#### **SECTION 6:MAINTENANCE AND CLEANING**

- Water inlet filters
- Pump filter
- Detergent drawer
- Siphon plug
- The cabinet
- The drum
- Removal of limescale

#### **SECTION 7: PRACTICAL INFORMATION**

#### **SECTION 8:AVOIDING MINOR FAULTS**

#### **SECTION 9:AUTOMATIC FAILURE DETECTION SYSTEM**

#### **SECTION 10:INTERNATIONAL WASHING SIGNS**

#### **SECTION 11:TECHNICAL SPECIFICATIONS**

## **SECTION 1:BEFORE USING**

### **SAFETY WARNINGS**

- Do not use a multiple socket or extension cord.
- Do not insert a plug with damaged or broken cord into the socket.
- If the cord is damaged it should be replaced by the manufacturer or appointed service agent in order to avoid a hazard.
- Never remove the plug from the socket by pulling from the cord section. Remove the plug by holding.
- Do not plug the power supply with wet hands.
- Never touch the machine with wet hands or feet.
- Never open the detergent drawer while the device is running.
- Never force to open the door of the machine while the machine is running.
- Since the machine can reach high temperatures while running, do not touch the drain hose and water during draining.
- In case of any failure, first unplug the device and close the water tap. Do not attempt to repair. Please apply to the nearest authorized service station.
- Do not forget that the packing material of your machine may be hazardous for children.
- Do not let your children play with the washing machine.
- Keep your pet away from your machine.
- Your machine should only be used by adults within the information written in this manual.
- Your machine is designed for use in house environment. Warranty will be invalid if you use it for commercial purposes.
- This product is designed in order to work with ambient temperature of 15-25 °C, but it can be used upto 35 °C ambient temperature.
- This appliance should not be installed on thick pile carpet.

### **RECOMMENDATIONS**

- The detergent or softener in contact with air for a long time will dry and stick to your detergent drawer. To avoid this put your detergent and softener into the detergent drawer just before washing.
- It is recommended that you use pre-washing program for only very dirty clothes.
- Please do not exceed the maximum loading capacity of 5 kg.

- If you will not use your machine for a long time, unplug your machine, close the water supply and leave the door open in order to keep the inside of the machine dry and for prevention from unpleasant odour.
- As a result of the quality control procedures, a certain amount of water may remain in your machine. This is not harmful for your machine.

## SECTION 2: INSTALLATION

You must pay attention to the following issues before using your washing machine.

### REMOVAL OF TRANSPORTATION SCREWS

- Transportation screws, which are located at the back side of the machine, must be removed before running the machine.
- Loosen the screws by rotating counterclockwise by a suitable wrench. (DIAGRAM-1)
- Remove the screws by pulling them.(DIAGRAM-2)
- Pull out the rubber plugs using a pair of grips.
- The plastic parts located in the interior part of your machine will fall down under the device.
- Lift your machine up slightly, pick up the plastic parts(2 persons recommended).
- If all of the plastic parts of screw groups have not fallen down; open the door of your machine,move the drum until all plastic parts fall down. Collect the parts that have fallen to the floor.
- To the holes where the transport screws have been removed, insert the plastic transport screw taps found in the accessories bag. (DIAGRAM-3)
- The transportation screws, that have been removed from the machine should be kept in hand for any other transportation necessities.

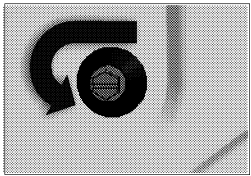

DIAGRAM-1

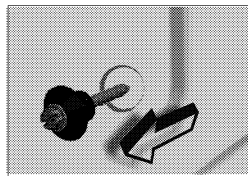

DIAGRAM-2

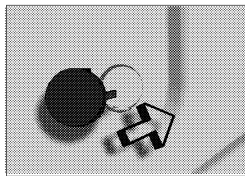
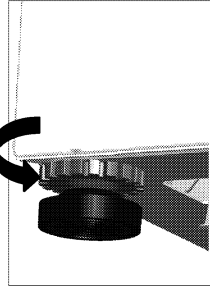

DIAGRAM-3

### ADJUSTMENT OF FEET

- Do not install your machine on rugs or similar surfaces.
- For your machine to work silently and without any vibration, it should be settled on a flat, non-slippery and tough ground.

- You can adjust the balance of your machine from its feet.
- First, loosen the plastic adjustment nut by turning clockwise(A).
- Adjust by rotating the feet upwards or downwards.
- After the balance has been reached, tighten the plastic adjustment nut again by rotating it upwards counter clockwise(B).
- Never put cartons, wooden blocks or similar materials under the machine to balance the irregularities on the level of the ground.



A

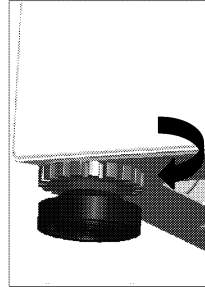

B

#### **ELECTRICAL CONNECTION**

- Your washing machine works with 220-240V and 50Hz.
- A special earthed plug has been attached to the network cable of your washing machine. This plug must definitely be inserted to a earthed socket with 10 ampere. The fuse flow value of the electricity line attached to this should also be 10 ampere. If you have no such sockets and fuses in your house, contact a qualified electrician.
- **Our company will not be responsible for any damages that may occur as a result of usage without earthing.**

#### **WATER SUPPLY CONNECTION**

- This model is designed for single cold fill only.
- To prevent leakage from the connection joints, make sure the seal at the end of water inlet hose is fitted.
- Connect the hose provided to the water inlet valve. Tighten the plastic parts of the connections with your hand. Please call a qualified plumber for safer connections.

- Water pressure of 1-10 bars from your tap will enable your machine to work more efficiently.(1 bar pressure means water flow of more than 8 liters in 1 minute from a fully opened tap).
- After connections are completed, check for the non-leakage of the connection joints by turning on your tap completely.
- Be sure that water inlet hoses are not folded, broken or crushed.
- Connect the other end of the water inlet hoses to a ¼", thread water tap.

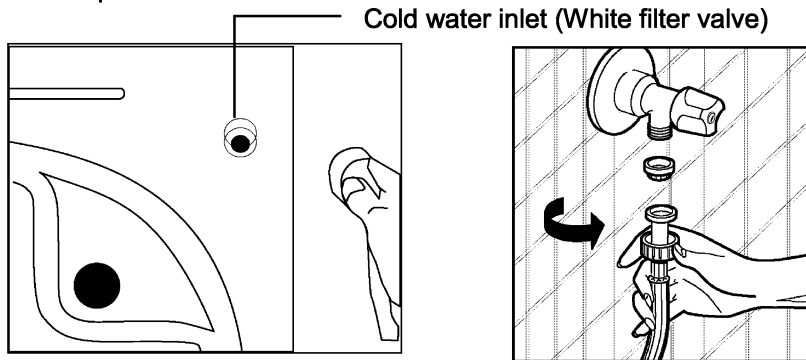

### WATER DRAIN CONNECTION

- Be sure that water inlet hoses are not folded, twisted, crushed or elongated by stretching.
- Water drain hose should be mounted at a height of minimum 60 cm, maximum 100 cm from the ground.
- The end of the water drain hose may directly be fitted to the dirty water outlet hole or a special apparatus mounted on the outlet bracket of the wash-stand.
- Never attempt to extend the water drain hose by adding extra parts.

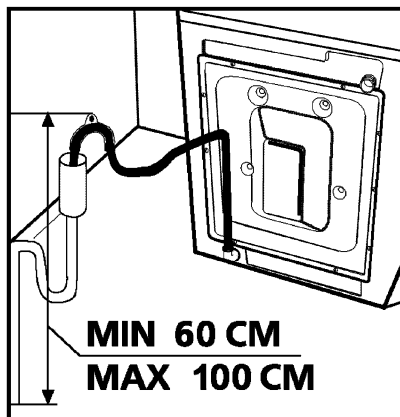

### SECTION 3: GETTING TO KNOW YOUR WASHING MACHINE

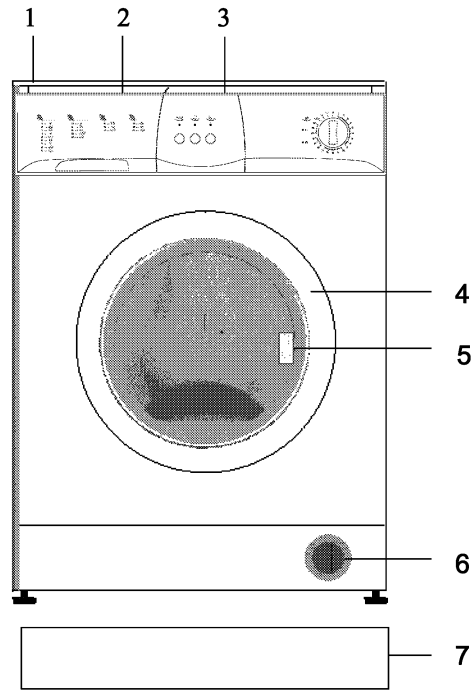

1-Upper tray  
2-Detergent drawer  
3-Control panel  
4-Door

5-Handle  
6-Filter cover  
7-Kickplate



## SECTION 4:CONTROL PANEL

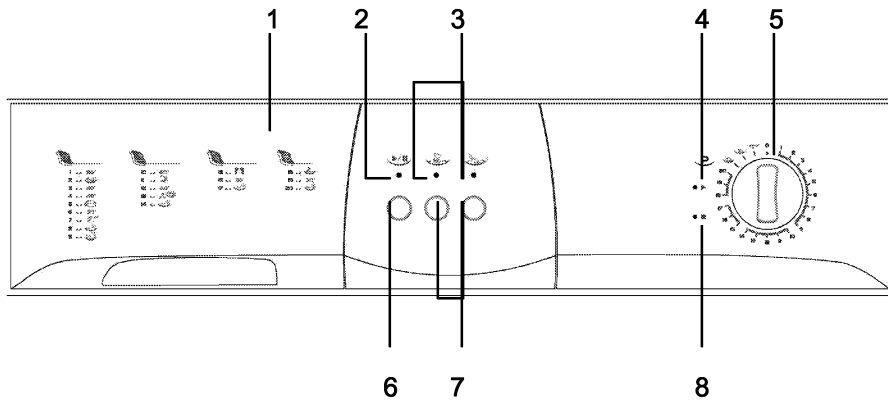

- 1-Detergent drawer
- 2-Start/pause light
- 3-Function indicator lights
- 4-Program ready light

- 5-Program knob
- 6-Start/pause button
- 7-Function buttons
- 8-Program end light

## START/PAUSE BUTTON



Used to start a selected program or pause during running.

### **WARNING!**

It is required for the program knob to be brought to O(off) position before selecting the program or changing a continuing program.

## FUNCTION INDICATOR LIGHTS



When the start/pause button or any function button is pressed, the corresponding light turns on. The light turns off when the function button or start/pause button is re-pressed, or when the process the selected function is completed.

The function indicator lights are also used in failure detection system mentioned in section 9.

## FUNCTION BUTTONS

### **Rinse hold**



This function is recommended to be used when the clothes cannot be taken immediately after the end of the program. This will prevent occurrence of wrinkles. When this button is pressed, the last rinsing water is not drained. For the program to continue from the same point, repress the same button.

### **Extra rinse**



You can have one more rinsing cycle in addition to the rinses which your machine has made in all washing programs by using this function.

**⚠ WARNING!**

Functions vary depending on the model you have chosen. If you forgot to use an additional function and your machine starts to wash, push the additional function button if the indicator light is on. Additional function will be activated. If the indicator light is not on, additional function will not be activated.

**OPTION COMPATIBILITIES**

	Rinse Hold	Extra Rinse	Easy Ironing	No Spin	Plus Water	Spin Speed Reduce	Soak
Rinse Hold		YES	NO	NO	YES	NO	YES
Extra Rinse			YES	YES	NO	YES	YES

**PROGRAM KNOB**

With the program knob, you can select the program with which you desire to wash your clothes. You can adjust the program selection process by turning the program knob in both directions. You must be careful that the adjustment sign of the program knob is exactly on the program you want to select. When you bring the program knob to O(off) position, while your machine is running, your program will remain incomplete.

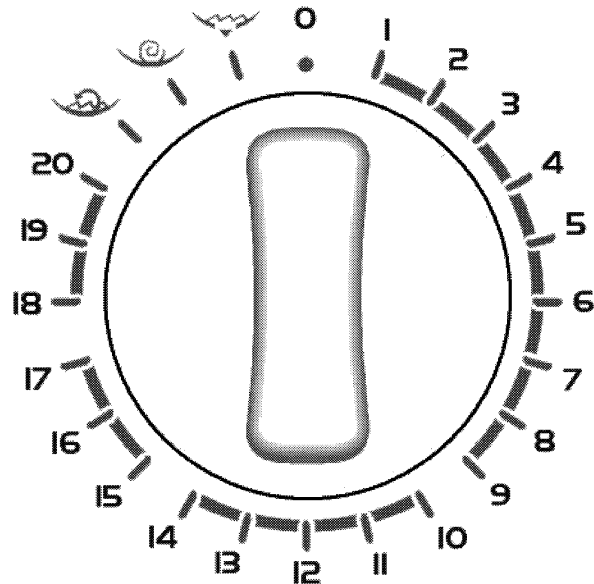

## SECTION 5: WASHING YOUR LAUNDRY

- Plug in the machine.
- Open the water supply.

### First wash cycle

There may be water left inside your machine after factory tests and trials. It is recommended that the first wash cycle should be made without any laundry so that carry out this water; pour half a measuring cup of normal allpurpose detergent into compartment 2 and select cotton program at 90°C.

### BEFORE WASHING

- Arrange your clothes according to their types (cotton, synthetic, sensitive, woolen, etc.), washing temperatures and level of dirtiness.
- Never wash your white and coloured clothes together.
- Since your new coloured clothes may shed dye on the first wash, wash them separately.
- Be careful that no metal pieces are found on or in the pockets of your clothes, remove if there is any.
- Zip and button your clothes.
- Remove the plastic or metal hooks of the curtains and laces or place them inside a washing bag and tie.

- Turn trousers, knitted fabric, t-shirt and sweat shirt inside out.
- Wash your small clothes like socks and handkerchiefs in a washing bag.



Wash up to 90 °C

Wash up to 60 °C

Wash up to 30 °C

Not machine washable

### Placement of the clothes into the machine

- Open the door of your machine.
- Place clothes in your machine.
- When you shut the door of your machine, be careful that nothing is jammed between the cover and the gasket.
- Shut the door of your machine tightly otherwise your machine will not start the washing process.

### Filling detergent in the machine

The quantity of the detergent that you will fill in your machine depends on the following criteria:

- Your detergent consumption will change according to the dirtiness level of your clothes. For your slightly dirty clothes, do not pre-wash and put a small amount of detergent in the compartment no.2 of the detergent drawer.
- For your excessively dirty clothes, select a program with pre-washing, fill ¼ portion of the detergent you will put in compartment 1 in the detergent drawer and the remaining portion in compartment 2.
- In your machine, use the detergents developed especially for automatic washing machines. The quantities that will be used for your clothes are written on the packing of the detergents.
- As the hardness of your water increases, the amount of the detergent to be consumed will also increase.
- As the amount of your clothes increases, the amount of the detergent to be consumed will also increase.
- Fill your softener in the softener compartment in your detergent drawer. Do not exceed the MAX level. Otherwise, the softener will diffuse in the washing water via the siphon.
- The softeners with high density should be diluted with some water before filling in the drawer. That is because the softener with high density obstructs the siphon and prevents the flow of the softener.

- You can use fluid detergents in all programs without pre-washing. For this, mount the fluid detergent level plate in the second compartment of the detergent drawer and arrange the amount of fluid detergent according to the levels on this plate.

## **RUNNING THE MACHINE**

### **Program selection and features**

Select the program and additional functions appropriate for your clothes from Table-1.

### **Start/Pause**

By pressing this button, you can start the program you have selected or pause a running program.

### **Starting the program**

- Adjust the program knob to a program you desire.
- The program ready light will be on.
- If you want, you can select one or more additional functions.
- Run the program which you have selected by pressing the Start/Pause button.

### **Changing the program**

If you have selected a program and you do not want it to continue:

- Press the start/pause button.
- Bring the program knob to O(off) status.
- Adjust the program knob to the program you desire.(You can select the program that you desire from Table-1).
- The program ready light will be on.
- By pressing the start/pause button, run the program which you have selected.

### **Cancellation of the Program**

If you desire to end a running program early:

- Press the start/pause button.
- Turn the program knob to O(off) status.
- Turn the program knob to "Draining" or "Spinning" programs.
- The program ready light will be on.
- Run the program you have selected by pressing the start/pause button.

### **Program ending**

- Your machine will automatically stop when the program you have selected ends.
- The program end light will be on.
- Turn the program knob to O(off) position.

- The door will be unlocked approximately two minutes after the program ends. You can open the door by pulling the handle of the door towards yourself and take out your clothes.
- After you unload your clothes leave the door open to dry the interior of your machine.
- Unplug your machine.
- Close the water tap.

 **WARNING!**

If the power supply is interrupted on any stage of the washing program, your machine will continue the program from the point where it was interrupted. This is not harmful for your machine.

**Child lock**

The Child Lock prevents unauthorised changes on the control panel while the machine is in operation. The child lock will be activated after the start/pause button on the control panel is pressed for a period longer than 2 seconds. To inactivate it, you have to press the same button for a period of longer than 2 seconds. At the end of the program child lock will automatically be off.

 **WARNING!**

Your machine will inactivate the spin speed selector and function buttons when the child lock is activated.









































PROGRAM	DETERGENT COMPART.	ADDITIONAL FUNCTION BUTTON		MAX DRY LOAD CAPACITY (kg) MWM1000N	TYPE OF LAUNDRY	EXPLANATIONS
						
1-COTTON 90°	2			5	Dirty, cotton and linen textile	Underwear, sheet, table cloth, t-shirt, shirt, towel
2-COTTON 60° (PREWASH)	1+2			5	Very dirty, cotton, coloured and linen textile	
3-COTTON 60°	2			5	Dirty, cotton, coloured and linen textile	
4-COTTON 40°	2			5	Slightly dirty, cotton, coloured and linen textile	
5-ECO WASH	2			5	Slightly dirty, cotton, coloured and linen textile	
6-COTTON 30°	2			5	Slightly dirty, cotton, coloured and linen textile	
7-QUICK WASH	2			2,5	Slightly dirty, cotton, coloured and linen textile	
8-COTTON COLD	2			5	Slightly dirty cotton, coloured and linen textile. Washed without heating the tap water.	
9-MIX WASH	2			5	Dirty or very dirty, stained , cotton, coloured and linen textile	
10-SYNTHETIC 60°	2			3	Dirty, synthetic or synthetic mixture textile	
11-BABY WASH	2			3	Baby laundry	
12-SYNTHETIC 40°	2			3	Slightly dirty, synthetic or synthetic mixture textile	

TABLE-1



PROGRAM	DETERGENT COMPART.	ADDITIONAL FUNCTION BUTTON	MAX DRY LOAD CAPACITY (kg)	TYPE OF LAUNDRY	EXPLANATIONS
13-SPORT CLOTHES	2	 	3	Sport clothes	All sport clothes and jeans
14-SYNTHETIC COLD	2	 	3	Slightly dirty, synthetic or synthetic mixture sensitive laundry.Cold water wash.	Nylon socks, blouse
15-CURTAIN WASH	1+2	 	2	Tulle and curtain as sensitive laundry	Tulle, curtain, diolen, dralon
16-DELICATE 30°	2	 	2	Slightly dirty, cotton, coloured, synthetic or synthetic mixture sensitive laundry	Silk mixture, shirt, blouse, polyester, poliarnid, mixture textile
17-DELICATE COLD	2	 	2	Very slightly dirty, cold water with to wash cotton, coloured, synthetic or synthetic mixture sensitive laundry	
18-HAND WASH	2	 	2	Slightly dirty, wash in hand cotton, coloured, synthetic or synthetic mixture laundry	Hand wash to all laundry
19-WOOL 30°	2	 	2	Dirty, hand and machine to wash wool laundry	
20-WOOL COLD	2	 	2	Very slightly dirty, cold water, hand and machine to wash wool laundry	All wool laundry
RINSING	When you need an additional rinsing to be done to your clothes after the washing process, you can use this program for all kinds of clothes.				
SPINNING	When you need an additional spinning to be done to your clothes after the washing process, you can use this program for all kinds of clothes.				
DRAINING	This program is used to drain the dirty water inside after the washing process of your machine. if you want the water inside your machine to be drained before the program ends, you can use this program.				

**TABLE-1 CONTINUE**

(\* ) You can use softeners in all programs (except spinning and draining programs) optionally. When you arrange the quantity of the softener, comply with the warning of the softener producer. Fill your softener in its  (softener) compartment of the detergent drawer.

## SECTION 6: MAINTENANCE AND CLEANING

- Unplug your machine.
- Close the water tap.

### WATER INLET FILTERS

On the tap part of your machine's water inlet hose and at the ends of water inlet valves, there are filters to prevent entrance of the dirt and foreign materials in the water to the machine. If the machine is unable to receive sufficient water although your water tap is opened, these filters should be cleaned.

- Remove the water inlet hose.
- Remove the filters found on the water inlet valves by using a pincer and wash thoroughly with a brush.
- Clean the filters of the water inlet hoses located on the tap side by removing manually together with the seal.
- After you clean the filters, you can fit them the same way as you have removed.

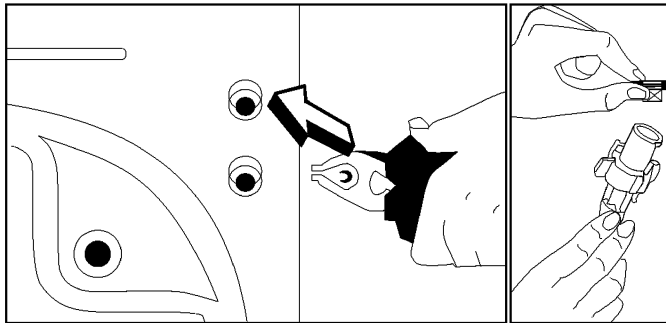

### PUMP FILTER

The pump filter system elongates the life of your pump, which is used to drain the dirty water. It prevents lint to enter the pump. Cleaning of your pump filter in every 2-3 months is recommended. To clean your pump filter:

- Remove the kickplate by pushing with your hand upwards from the lower indents under the cover and pulling towards yourself.
- Before opening the filter cover, place a cup in front of the filter cover to prevent flow of the remaining water in the machine.
- Loosen the filter cover by rotating it counter clockwise and drain the water.
- Remove the foreign materials from the filter.
- Check for the rotation of the pump manually.
- After you have cleaned the pump, fit the filter cover by rotating clockwise.
- Fit in the kickplate by clipping it back into position.
- Do not forget that if you do not fit in the filter cover properly, it will leak water.

**⚠ WARNING!**

**Danger of being scalded!**

Since the water inside the pump may be hot, wait for it to cool.

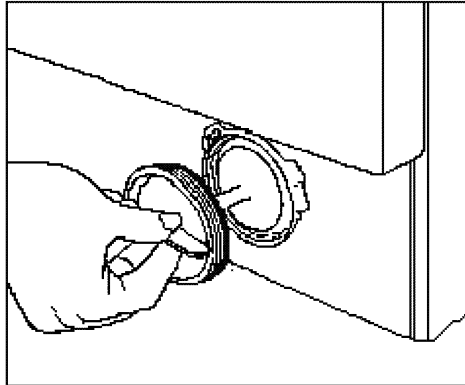
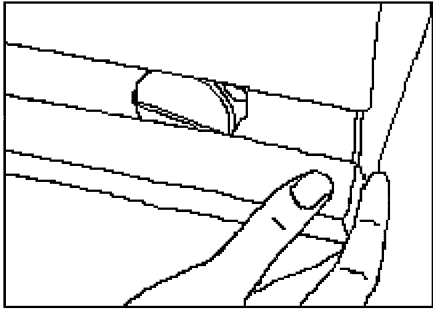

**DETERGENT DRAWER**

Detergents may form a sediment in your detergent drawer or in housing of the detergent drawer in time. To clean the sediment, pull out the detergent drawer from time to time. To pull out the detergent drawer:

- Pull the detergent drawer to the end.(DIAGRAM-1)
- Lift the front of the drawer, continue to pull while pressing the tab on the softner compartment until the drawer is pull out.(DIAGRAM-2)
- Wash with an old toothbrush and excessive amount of water.
- Take off the leftover detergent avoid to drop into your machine.
- After drying the detergent drawer put into the housing in the same manner you pull out.

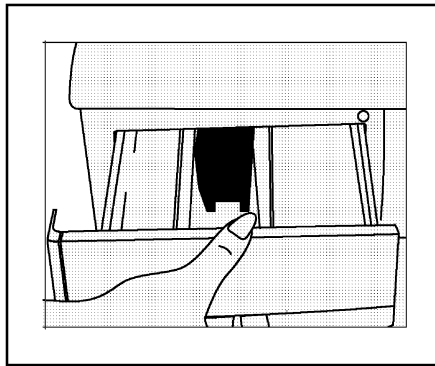

DIAGRAM-1

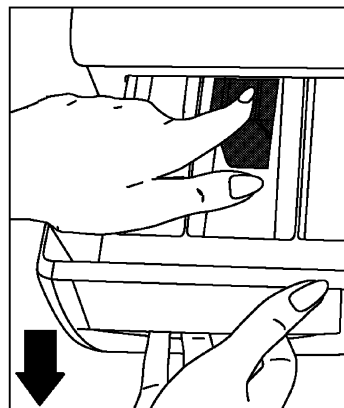
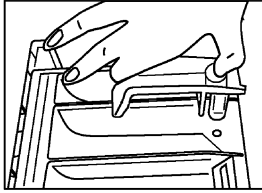

DIAGRAM-2

## SIPHON PLUG

Pull out the detergent drawer. Remove the siphon plug and clean the residues of the softener thoroughly. Fit the cleaned siphon plug in its location. Check if it placed properly.



## THE CABINET

Clean the exterior surface of the cabinet of your machine with lukewarm water and a cleaning substance that will not irritate the cabinet. After rinsing with clean water, wipe it with a soft and dry cloth.

### ⚠ WARNING!

If the machine is installed in a location where the ambient temperature can fall below 0 °C, do the following when it will not be in use:

- Plug in the machine.
- Close the water tap and pull out the water inlet hose or hoses from the tap.
- Place the ends of the water drain and water inlet hoses in a cup on the ground.
- Adjust the program knob to “Draining” program.
- The program ready light will be on.
- Run the program by pressing the start/pause button.
- Unplug your machine when the program is over (program end light is on).

When you complete these proces, the remaining water inside the machine will be drained and thus formation of ice in the machine will be prevented. When you operate your machine again, be sure that the ambient temperature is above 0 °C.

## THE DRUM

Do not leave metal parts like needles, staples or coins inside your machine. These pieces cause formation of rust stains in the drum. To eliminate these stains of rust, use a cleaning substance without chlorium and follow the warnings of the cleaning substance producer. For cleaning of the rust stains, never use dish-washing wires or similar rough objects.

## REMOVAL OF LIME FROM YOUR MACHINE

If you arrange the amount of the detergent you use in your machine properly, there will be no need for lime removal. However, if you desire to apply the removal procedure, use the lime protectors in the market and pay attention to their warnings.

### ⚠ WARNING!

The lime eliminating substances contain acids and this may cause colour modifications in your clothes along with an adverse effect on your machine.

## SECTION 7: PRACTICAL INFORMATION

**Alcoholic beverages:** The stain point, should first be washed with cold water, then should be wiped with glycerine and water and be rinsed with water mixed with vinegar.

**Shoe Polish:** The stain should be slightly scratched without ruining the cloth, rubbed with detergent and rinsed. In case it is not eliminated, it should be rubbed with 1 unit of pure alcohol (96 degrees) mixed in 2 units of water and then washed with lukewarm water.

**Tea and coffee:** Stretch the stained area of your cloth on the top of a container and pour water as hot as the type of your cloth can endure on it. If the type of your cloth is suitable, wash it with lye (caustic soda).

**Chocolate and cocoa:** By leaving your clothes in cold water and rubbing with soap or detergent, wash it in the highest temperature that the type of your cloth can endure. If there is still a stain of oil left, wipe with oxygenated water (in proportion of 3%).

**Tomato paste:** After scraping the dried pieces without ruining the cloth, leave in cold water for about 30 minutes and wash by rubbing with detergent.

**Egg:** Eliminate the dried stain residues and wipe with a sponge or damp cloth. Rub with detergent and wash with diluted lye (caustic soda).

**Grease and oil stains:** First wipe the residues. Rub the stain with detergent and then wash with lukewarm soapy water.

**Mustard:** First apply glycerine to the stained area. Rub with detergent and then wash. If the stain still does not disappear, wipe with alcohol (On synthetic and coloured cloth, a mixture of 1 unit alcohol, 2 units water should be used)

**Blood stain:** Lay your clothes in cold water for 30 minutes. If the stain still does not disappear, lay in mixture of water and ammonia (3 table-spoons of ammonia in 4 liters of water) for 30 minutes.

**Cream, ice-cream and milk:** Lay your clothes in cold water and rub the stained area with detergent. If the stain has still not disappeared, apply lye on the fabric of your clothes in proper proportion. (Do not use lye on coloured clothes.)

**Mould:** Mould stains should be cleaned as soon as possible. The stain should be washed with detergent.

**Ink:** Hold the stained area under cold water and wait until the inky water completely runs off. Then rub with water diluted with lemon juice and detergent, wash after waiting for 5 minutes.

**Fruit:** Stretch the stained area of your clothes on the top of a container and pour cold water on it. Do not pour hot water on the stain. Wipe with cold water and apply glycerine. Wait for 1-2 hours and rinse after wiping with a few drops of white vinegar.

**Grass stain:** Rub the stained part with detergent. If the type of fabric is suitable for use of lye, wash it with lye. Rub your woolen clothes with alcohol.(For coloured ones, a mixture of 1 unit pure alcohol and 2 units of water).

**Oil Paint:**The stain should be eliminated before it dries by applying thinner on it. Then it should be rubbed with detergent and washed.

**Burnt stain:** If your cloth is suitable for use of lye, you can add lye into your washing water. For woolen fabric, a cloth damped in oxygenated water should be covered on the stain and it should be ironed with a dry cloth on it. It should be washed after rinsing well.

## **SECTION 8: AVOIDING MINOR FAULTS**

All repairing which must be done on the machine should be done by authorized service. When a repairing is required for your machine or you are unable to eliminate the failure with the help of the information given below:

- Unplug the machine.
- Close the water tap.
- Apply to the nearest authorized service station.

<b>FAILURE</b>	<b>PROBABLE CAUSE</b>	<b>METHODS OF ELIMINATION</b>
Your machine does not operate.	It is unplugged.	Insert the plug into the socket.
	Your fuse is defected.	Change your fuse.
	The electric power is off.	Check the electric power.
	Start/pause button has not been pressed.	Press the start/pause button.
	The program knob is in O(off) status.	Bring the program knob on the desired status.
	The door is not shut properly.	Shut the door properly. You should hear the click.
Your machine does not receive water.	Water tap is closed.	Open water tap.
	The water inlet hose may be bent.	Check the water inlet hose.
	The water inlet hose is obstructed.	Clean the filters of water inlet hose. (*)
	The valve inlet filter is obstructed.	Clean the valve inlet filters. (*)
	The door is not shut properly.	Shut the door properly. You should hear the click.
Your machine is not draining water.	The drain hose is obstructed or bent.	Check the drain hose.
	The pump filter is obstructed.	Clean the pump filter. (*)
Your machine is vibrating.	The feet of your machine are not adjusted.	Adjust the feet. (**)
	Transportation screws are not removed.	Remove transportation screws. (**)

(\*)See the section concerning the maintenance and cleaning of your machine.

(\*\*)See the section concerning installations your machine.

<b>FAILURE</b>	<b>PROBABLE CAUSE</b>	<b>METHODS OF ELIMINATION</b>
Your machine is vibrating.	There is a small amount of clothes in the device.	It does not prevent operation of the machine.
	Excessive amount of clothes are filled in the machine.	Do not exceed the recommended quantity of clothes and spread your clothes.
	Your machine touches a rigid object.	Prevent your machine's leaning on a tough place .
Excessive foam in the detergent drawer.	Too much detergent has been used.	Press the start/pause button. In order to stop the foam, dilute one table-spoon of softener in half liter of water and pour it in the detergent drawer. Press the start/pause button after 5-10 minutes. Arrange the amount of the detergent properly in the next washing process.
	Wrong detergent has been used.	Use only the detergents produced for full automatic machines.
The washing result is poor.	Your laundry is too dirty for the program you have selected.	Select a suitable program. (see Table-1)
	The amount of detergent used is not sufficient.	Use more detergent according to the detergent.



FAILURE	PROBABLE CAUSE	METHODS OF ELIMINATION
The washing result is not good.	Clothes exceeding the maximum capacity has been filled in your machine.	Put the clothes in your machine in a manner not to exceed its maximum capacity.
	Your water may be hard.	Use the amount of detergent according to the declaration of the detergent producer.
	Distribution of the clothes in your machine is not well-balanced.	Spread the clothes inside the machine in an orderly and well-balanced manner .
The water is drained from the machine as soon as it is filled.	The end of the water drain hose is in a position too low according to the machine.	Place the water drain hose in an appropriate height.(**)
No water is seen in the drum during washing.	No failure. The water is at the lower part of the drum.	-
There are gray stains on the clothes.	These stains may be caused by oil,cream or ointment .	In the next washing operation, use the maximum detergent amount declared by the detergent producer.

(\*\*) See the section concerning instalations your machine.

FAILURE	PROBABLE CAUSE	METHODS OF ELIMINATION
The spinning process is not done or starts with delay .	No failure. An unbalanced load can cause this.	The unbalanced load control system will try to distribute your clothes in a homogenous manner. After your clothes are distributed, spinning process will begin. In the next washing process, place your clothes into the machine in a well-balanced manner.

## SECTION 9: AUTOMATIC FAILURE DETECTION SYSTEM

Your machine is equipped with systems which will both take the necessary precautions and warn you in case of any failure by controlling itself constantly during the washing processes.





FAILURE CODE	FAILURE INDICATOR	PROBABLE FAILURE	THE PROCESS TO BE DONE
Err 01	The start/pause light blinks.	The door is not shut properly.	Shut the door properly so that you hear the click. If the problem persists, turn off the machine unplug and apply to the nearest authorized service immediately.





FAILURE CODE	FAILURE INDICATOR	PROBABLE FAILURE	THE PROCESS TO BE DONE
Err 02	The program ready light blinks.	The water level in your machine is below heater. The pressure of your water supply may be low or locking.	Turn on the tap to the end. Water may be cut, check it. If the problem is still continuing, your machine will automatically stop after a while. Unplug your machine, turn off the tap and apply to the nearest authorized service.
Err 03	The start/pause light and program ready light blinks .	The pump has failed or the pump filter is obstructed.	Clean the pump filter. If the problem persists, apply to the nearest authorized service. (*)





(\*) See the section regarding the maintenance and cleaning of your machine.



<b>FAILURE CODE</b>	<b>FAILURE INDICATOR</b>	<b>PROBABLE FAILURE</b>	<b>THE PROCESS TO BE DONE</b>
Err 05	The start/pause light and program end light blink.	The heater of your machine or the heat sensor has failed.	Shut down your machine and unplug. Turn off your tap and apply to the nearest authorized service.
Err 06	The program ready light and program end light blink.	The motor has failed.	Shut down your machine and unplug. Turn off the tap and apply to the nearest authorized service.
Err 07	The program start/pause light, ready light and program end light stays on permanently.	Configuration error.	Shut down your machine and unplug. Turn off the tap and apply to the nearest authorized service.
Err 08	The start/pause light, program ready light and program end light blink.	The motor has failed.	Shut down your machine and unplug. Turn off the tap and apply to the nearest authorized service.
Err 09	The program ready light and program end light stays on permanently.	The network voltage is too high or too low.	If the network voltage is lower than 150V or higher than 260V, your machine will automatically stop. When the network voltage is recovered, your machine will continue its operation.

## SECTION 10: INTERNATIONAL WASHING SIGNS

			
Washing temperature.	Do not wash (hand wash)	Lukewarm iron.	Medium hot iron.

			
Hot iron.	Do not iron.	Do not tumble dry.	Hang to dry.

			
Drip dry.	Dry flat.	Do not bleach.	Handy to bleach.

		
<p>All of these are dry cleaning symbols. The letters are to instruct the cleaner what type of solvent to be used. Garments bearing these symbols should not be washed in your machine unless the label says otherwise.</p>		

## SECTION 11: TECHNICAL SPECIFICATIONS

	MWM1000N
<b>Rated voltage(V)</b>	<b>230</b>
<b>Rated power(W)</b>	<b>2200</b>
<b>Weight(kg)</b>	<b>65</b>
<b>Maximum dry laundry capacity (kg)</b>	<b>5</b>
<b>Recommended loading (kg)</b>	<b>4,5</b>
<b>Height (cm)</b>	<b>85</b>
<b>Width (cm)</b>	<b>59,6</b>
<b>Depth (cm)</b>	<b>51</b>
<b>Maximum spin cycle ( rpm )</b>	<b>1000</b>



This symbol on the product or in the instructions means that your electrical and electronic equipment should be disposed at the end of its life separately from your household waste. There are separate collection systems for recycling in the EU. For more information, please contact the local authority or your retailer where you purchased the product.



52007871