

# MATSUI

---

**MAT15LI618**



**OPERATING INSTRUCTIONS**

**COLOUR TELEVISION WITH REMOTE CONTROL**



50122416

## Contents

Features .....	3	EPG Preference .....	25
Accessories .....	3	Receiver Upgrade .....	26
Introduction .....	4	Automatic Download	
Preparation .....	4	(Automatic Upgrade) .....	26
Safety Precautions .....	4	Search for New Version (Manual	
Overview of the Remote Control .....	7	Upgrade) .....	26
LCD TV and Operating Buttons .....	8	Parental Settings .....	26
Viewing the Connections .....	9	Timers .....	27
Power Connection .....	11	Language .....	28
Aerial Connection .....	11	TV Setup .....	28
Connecting to a DVD Player .....	12	Common Interface .....	28
Using Other Connectors .....	13	Navigating the Analogue TV Menu System .....	29
Connecting Other Equipment via Scart .....	14	Analogue TV Menu Map .....	30
Inserting Batteries in the Remote		Analogue TV Menu System .....	31
Control Handset .....	15	Sound Menu .....	31
Operating Range for the Remote Control .....	15	Volume .....	31
Switching the TV On/Off .....	16	Balance .....	31
To Switch the TV On .....	16	Sound Mode .....	31
To switch the TV off .....	16	AVL .....	31
Input Selection .....	16	Effect .....	31
Basic Operations .....	17	Equalizer .....	31
Operation with the Buttons on the TV .....	17	HP Volume .....	31
Volume Setting .....	17	Store .....	31
Programme Selection .....	17	Picture Menu .....	31
Entering Main Menu .....	17	Picture Mode .....	31
AV Mode .....	17	Brightness/Contrast/Colour/ .....	32
Operation with the Remote Control .....	17	Sharpness/Tint .....	32
Volume Setting .....	17	Colour Temp .....	32
Programme Selection (Previous or Next		Room Lighting .....	32
Programme) .....	17	Picture Zoom .....	32
Programme Selection (Direct Access) .....	17	Store .....	32
Initial Settings .....	18	Features Menu .....	32
General Operation .....	18	Sleep Timer .....	32
Information Banner .....	18	Language .....	32
Electronic Programme Guide (EPG) .....	19	Child Lock .....	32
Displaying the Subtitles .....	20	Menu Colour .....	32
Digital Teletext .....	20	Favourite Mode .....	32
Over Air Download .....	21	Install Menu .....	33
Widescreen .....	21	Programming .....	33
IDTV Menu System .....	21	Programme .....	33
Channel List .....	21	Band .....	33
Navigating the Entire Channel List .....	22	Channel .....	33
Deleting the Channels in the Channel List ...	22	Standard .....	33
Renaming Channels .....	22	Colour System .....	33
Adding Locks to Channels .....	22	Search .....	33
Setting Favourites .....	23	VCR Mode .....	33
On Screen Help .....	23	Decoder .....	33
Installation .....	23	Store .....	33
Add New Channels .....	24	A.P.S. .....	34
Automatic Search .....	24	A.P.S. Country .....	34
Manual Search .....	24	Teletext Region .....	34
Configuration .....	25	Install menu in AV modes .....	34
Audio Language .....	25	Programming .....	34
Subtitle .....	25	Colour System .....	34
Favourite Mode .....	25		

Program Table .....	34
Name .....	35
Move .....	35
Delete .....	35
APS (Auto Programming System) .....	35
Favourite Mode .....	35
Program Lock .....	35
Enter PIN .....	35
Change PIN .....	35
Displaying TV Information .....	36
Mute Function .....	36
Personal Preference .....	36
Zoom Modes .....	36
Auto .....	36
4:3 .....	36
16:9 .....	36
Cinema .....	37
Subtitle .....	37
Teletext .....	37
Tips .....	38
Screen Care .....	38
No Power .....	38
Poor Picture .....	38
Input Sources .....	38
CI Module .....	38
Specifications .....	39
Pin Specifications .....	40
Important Instruction .....	41

Visit [Partmaster.co.uk](http://Partmaster.co.uk) today for the easiest way to buy electrical spares and accessories.

With over 50,000 products in stock we can deliver direct to your door the very next day.



Visit [www.partmaster.co.uk](http://www.partmaster.co.uk)

or call

0870 6001 338

(UK customers only)

Calls charged at National Rate.

## Features

- Remote controlled colour television.
- Fully integrated digital TV (DVB-T).
- 100 programmes from VHF, UHF bands or cable channels can be preset.
- It can tune cable channels.
- Controlling the TV is very easy by its menu driven system.
- It has a scart socket for external devices (e.g. video games, audio set, etc.).
- Stereo sound system (**German+Nicam**).
- Full function teletext.
- Fastext (10 pages), top text.
- Favourite channel.
- Channel lock.
- Headphone connection.
- A.P.S. (Automatic Programming System).
- All programmes can be named.
- Forward or backward automatic tuning.
- Sleep timer.
- Child lock.
- Automatic sound mute when no transmission.
- NTSC playback.
- AV in is available.
- AVL (automatic volume limiting).
- When no valid signal is detected, after 5 minutes the TV switches itself automatically to standby mode.
- PLL (frequency search).

## Accessories



Remote Controller  
Part Number: 30054028

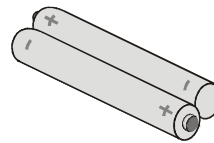

Batteries  
Part Number: 30002391  
2 XAAA

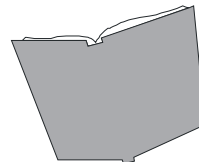

Instruction Book

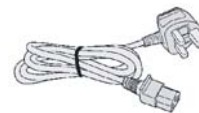

Power Cord : **British Plug**  
Part Number: 30002375

## Introduction



Thank you for choosing this product. This manual will guide you for the proper operation of your TV. Before operating the TV, please read this manual throughly.

Please do keep this manual in a safe place for future references.

## Preparation

For ventilation, leave a free space of at least 10 cm all around the set. To prevent any fault and unsafe situations, please do not place any objects on top of the set.

Use this device in moderate climates.

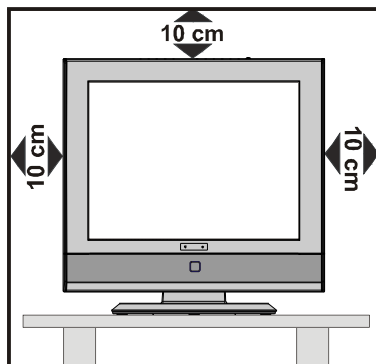

## Safety Precautions

Please read the following recommended safety precautions carefully for your safety.

### Power

- Always use the provided AC adaptor.
- Operate only from the power source specified on the AC adaptor.
- The power adaptor may become hot during normal operation. This is not a malfunction.
- Please make sure that the adaptor is not covered while in operation. Leave a space of 15 cm (minimum) around the AC adaptor.
- The rating information and safety caution of the AC adaptor are provided on the adaptor.

**WARNING:** When the set is not in use for a long time, disconnect from the power.

### Power Cord

Do not place the set, a piece of furniture, etc. on the power cord (mains lead) or pinch the cord. Handle the power cord by the plug. Do not pull out the plug by tugging the cord and never touch the power cord when your hands are wet as this could cause a short circuit or electric shock. Never make a knot in the cord or tie it with other cords. The power cords should be placed in such a way that they are not likely to be stepped on. A damaged power cord can cause fire or give you an electric shock. When the power cord is damaged and needs to be replaced, it should be done by qualified personnel.

### Moisture and Water

Do not use this device in a humid and damp place (avoid the bathroom, the sink in the kitchen, and near the washing machine). Do not expose this equipment to rain or water, as this may



be dangerous and do not place objects filled with liquids, such as flower vases, on top of the set. Avoid from dripping or splashing.

If any solid object or liquid falls into the cabinet, unplug the set and have it checked by qualified personnel before operating it any further.

### Cleaning

Before cleaning, unplug the adaptor from the wall outlet. Do not use liquid or aerosol cleaners. Use soft and dry cloth.

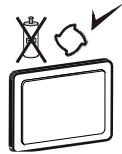

### Ventilation

The slots and openings on the back cover are intended for ventilation and to ensure reliable operation. To prevent overheating, these openings must not be blocked or covered in anyway.

### Heat and Flames

The set should not be placed near to open flames and sources of intense heat, such as an electric heater. Ensure that no open flame sources, such as lighted candles, are placed on top of the set. Batteries shall not be exposed to excessive heat such as sunshine, fire or the like.



### Lightning

In case of storm and lightning or when going on holiday, disconnect the power cord from the wall outlet.



### Replacement Parts

When replacement parts are required, make sure that the service technician has used replacement parts, which are specified by the manufacturer or have the same specifications as the original one. Unauthorized substitutions

may result in fire, electrical shock or other hazards.

### Servicing

Please refer all servicing to qualified personnel. Do not remove the cover yourself as this may result in an electric shock.



### Waste Disposal

Instructions for Waste Disposal

- Packaging and packaging aids are recyclable and should principally be recycled. Packaging materials, such as foil bag, must be kept away from children.
- Batteries, including those which are heavy metal-free, should not be disposed of with household waste. Please dispose of used battery in an environment friendly manner. Find out about the legal regulations which apply in your area.
- Cold cathode fluorescent lamp in LCD PANEL contains a small amount of mercury; please follow the local laws or regulations for disposal.

### Information for Users in European Union Countries



This symbol on the product or on its packaging means that your electrical and electronic device should be disposed at the end of its service life separately from your household wastes. There are separate collection systems for recycling in EU.

For more information, please contact the local authority or the dealer where you purchased the product.

### Disconnecting the Device

The mains plug is used to disconnect TV set from the mains and therefore it must remain readily operable.

### Headphone Volume

Excessive sound pressure from earphones and headphones can cause hearing loss.



### Installation

To prevent injury, this device must be securely attached to the wall in accordance with the installation instructions when mounted to the wall (if the option is available).

### LCD Screen

The LCD panel is a very high technology product with about a million thin film transistors, giving you fine picture details. Occasionally, a few non-active pixels may appear on the screen as a fixed blue, green or red point. Please note that this does not affect the performance of your product.

### Warning

Do not leave your TV in standby or operating mode when you leave your house.

### Connection to a Television Distribution System (Cable TV etc.) from Tuner

Device connected to the protective earthing of the building installation through the mains connection or through other apparatus with a connection to protective earthing - and to a television distribution system using coaxial cable, may in some circumstances create a fire hazard.

To ground the antenna system properly, be sure that the cable grounding is connected with the building's grounding system. Note that the connection should follow IEC 60364-7-707 and IEC 603646-5-548 standards which require that the grounding should be as close as possible to the cable connection.

### Be sure to ground the connection properly.

Connect the ground terminal of the AC adaptor with the ground terminal provided at the power outlet using the enclosed power cord. If the provided plug does not fit your outlet, consult an electrician for replacement of the obsolete outlet.



Surely connect the ground wire

## Overview of the Remote Control

- ① Standby
- ② Switch to TV
- ③ Mono-Stereo/Dual I-II
- ④ Direct programme
- ⑤ Double digit
- ⑥ Cursor up
- ⑦ Cursor left
- ⑧ Programme up
- ⑨ Programme down
- ⑩ Previous programme
- ⑪ External source
- ⑫ Time/Sub-page/Subtitle on-off
- ⑬ Teletext
- ⑭ Expand/Image size
- ⑮ Reveal
- ⑯ Index page/Electronic Programme Guide (EPG)
- ⑰ Mix
- ⑱ Update
- ⑲ Hold
- ⑳ Personal preference
- ㉑ TV button (Exit Menu or Teletext)
- ㉒ Volume down
- ㉓ Volume up
- ㉔ Cursor down
- ㉕ Cursor right
- ㉖ Okay
- ㉗ Install Menu
- ㉘ Menu
- ㉙ Feature Menu
- ㉚ Picture Menu/Page down
- ㉛ Sound Menu/Page up
- ㉜ Switch to DVD mode
- ㉝ Switch to DTV mode
- ㉞ Mute
- ㉟ Info/Programme Table

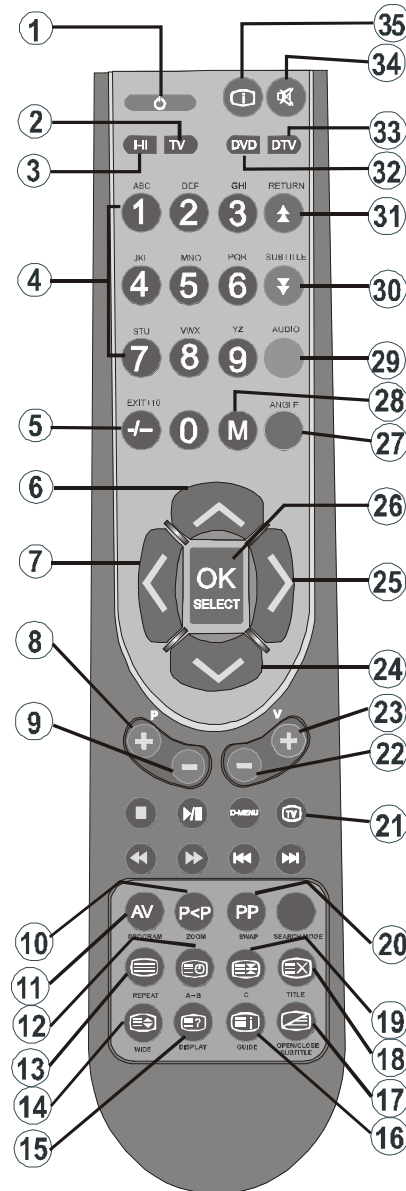

## LCD TV and Operating Buttons

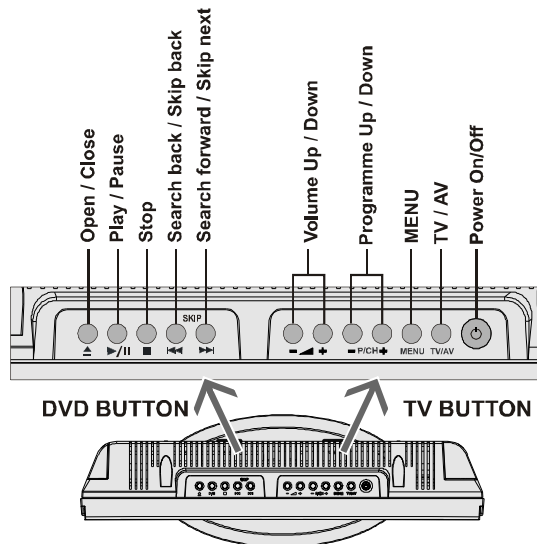
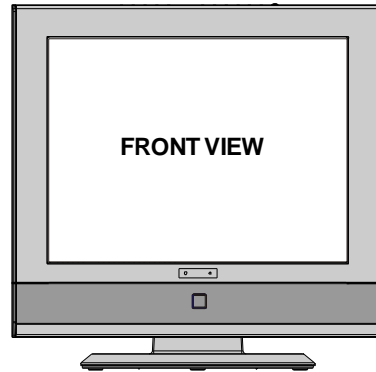

TOP VIEW

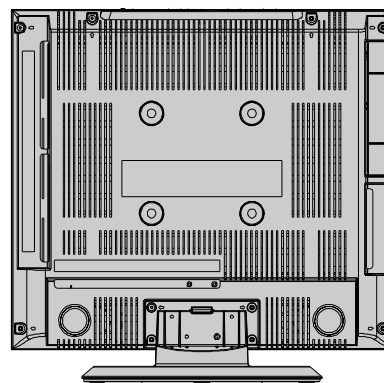

REAR VIEW

## Viewing the Connections

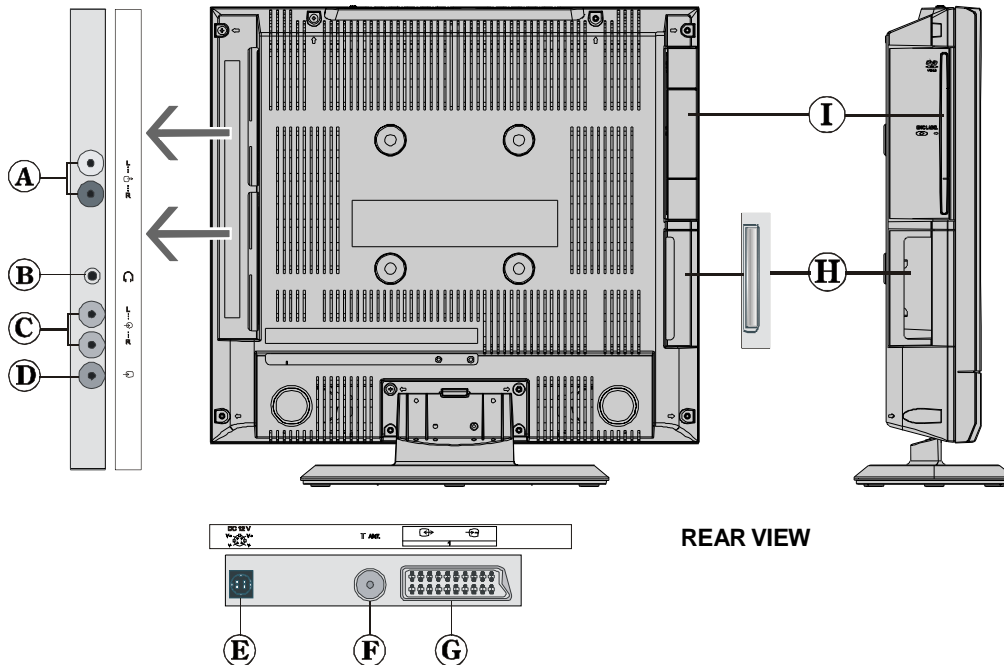

Ⓐ **Audio Line Outs** output audio signals to an external device such as an optional sound system.

To connect the external speakers to your TV, use **AUDIO LINE OUTS** of the TV with an audio cable.

Ⓑ **Headphone** jack is used for connecting an external headphone to the system. Connect to the **HEADPHONE** jack to listen to the TV from headphones (optional).

Ⓒ **Audio Inputs** are used for connecting audio signals of external devices.

Connect the audio cable between the **AUDIO INPUTS** on the TV and the **AUDIO OUTPUT** jacks on your device.

Ⓓ **Video Input** is used for connecting video signals of external devices.

Connect the video cable between the **VIDEO IN** socket on the TV and the **VIDEO OUT** jack on your device.

Ⓔ **DC 12 V Input** is used for connecting the supplied power adaptor.



Ⓕ **RF Input** connects to an antenna or a cable.

Note that if you use a decoder or a media recorder, you should connect the aerial cable through the device to the television with an appropriate antenna cable, as shown in the illustration below.

Ⓖ **SCART** inputs or outputs for external devices.

Connect the **SCART** cable between **SCART** sockets on TV and **SCART** socket on your external device (such as a decoder, a VCR or a DVD player).

**Note:** *If an external device is connected via the **SCART** sockets, the TV will automatically switch to AV mode. If both sockets are employed at the same time, **SCART 1** becomes the preferential.*

⑧ **CI Slot** is used for inserting a CI card. A CI card allows you to view all the channels that you subscribe to. For more information, see “Common Interface” section.

⑨ **Disc Loader**

## Power Connection

- After unpacking, allow the TV set to reach the ambient room temperature before you connect the set to the mains.

**IMPORTANT:** The TV set is designed to operate on 12 V DC. For this, an adaptor is used which gives 12 V voltage. Connect this adaptor to a system that supplies 220-240V AC 50Hz.

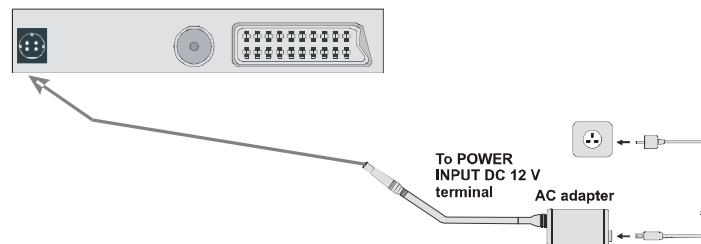

## Aerial Connection

- Connect the aerial or cable TV plug to the **AERIAL INPUT** socket located at the rear of the TV.

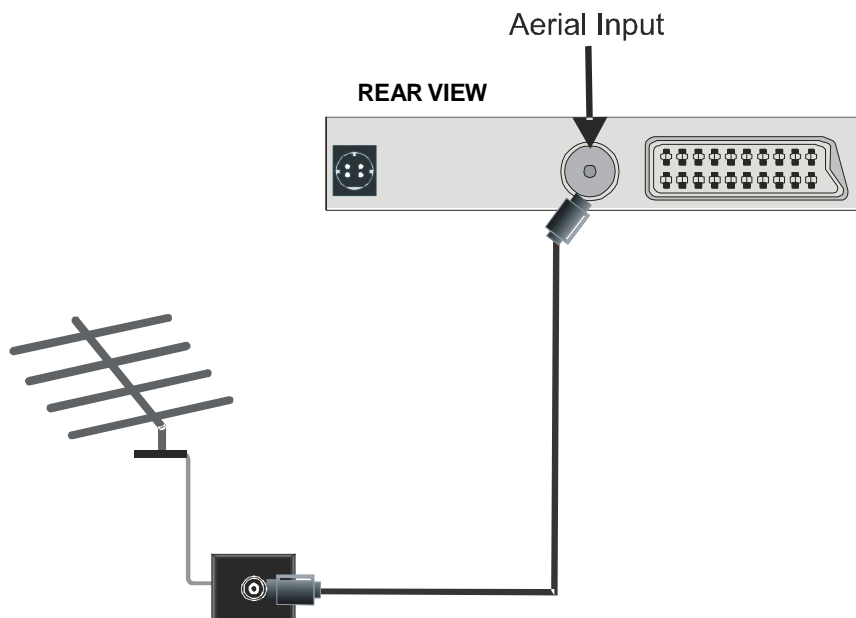

## Connecting to a DVD Player

If you want to connect a DVD player to your LCD TV, you can use connectors of the TV set. DVD players may have different connectors. Please refer to your DVD player's instruction book for additional information. Power off both the TV and the device before making any connections.

**Note:** Cables shown in the illustration **are not supplied**.

- Most DVD players are connected through **RCA SOCKETS**. Use a RCA video cable to connect video input. For enabling audio, use a component audio cable as illustrated below. When done, switch to **EXT1** source. See, "**Input selection**" section.
- You may also connect through the **SCART (EXT2)**. Use a **SCART** cable as shown below.

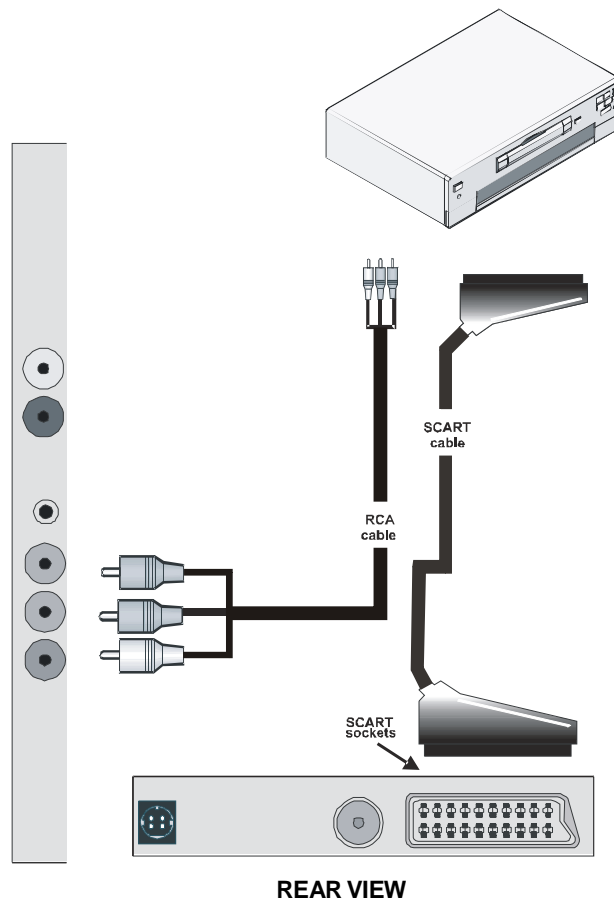

**Note:** These three methods of connection perform the same function but in different levels of quality. It is not necessary to connect by all three methods.

## Using Other Connectors

You can connect a range of optional equipment to your LCD TV. Possible connections are shown below. *Note that cables shown in the illustration are not supplied.*

- For connecting a camcorder, connect to the **VIDEO IN** socket and the **AUDIO SOCKETS**. Do not connect the camcorder to **VIDEO IN** socket at the same time since it can cause noise in the picture. For selecting the related source, see the section “**Input selection**” in the following parts.
- To connect external speakers, use an audio cable. Do not reverse the **AUDIO LEFT** and **AUDIO RIGHT** jacks. Turn on the LCD TV and external speaker set after all connections are made. Refer to your speaker set's manual for further queries.
- To listen the sound from headphones, connect to the **HEADPHONE** jack of the TV.

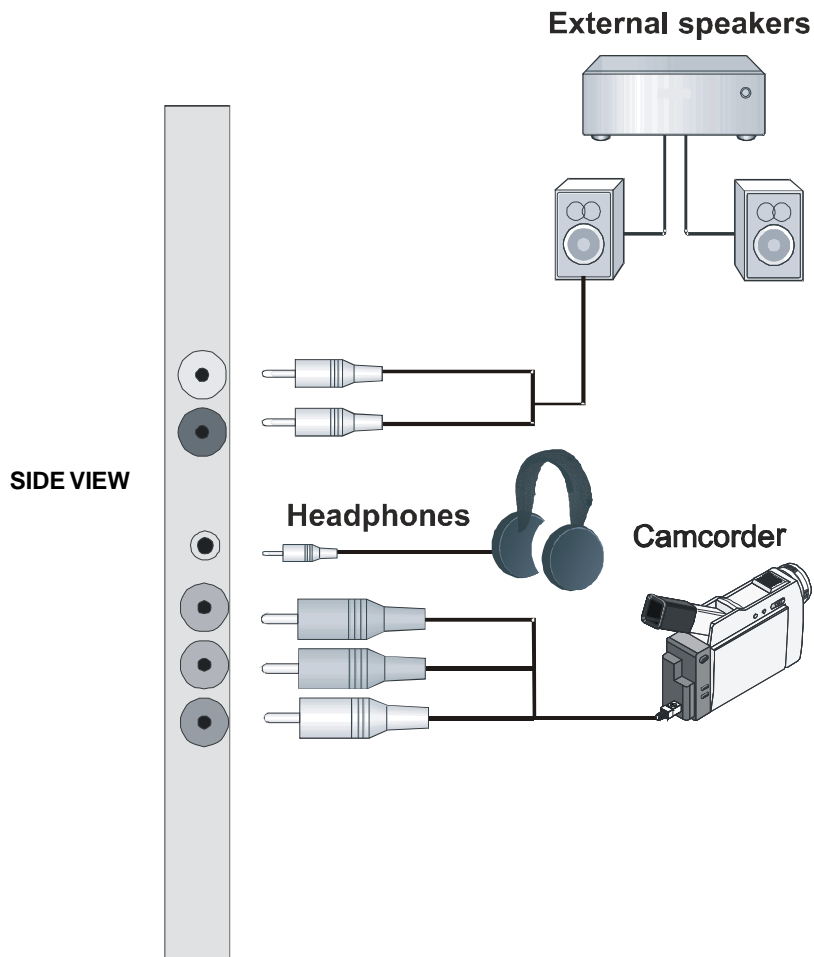

## Connecting Other Equipment via Scart

Most devices support **SCART** connection. You can connect a; DVD recorder, a VCR or a decoder to your LCD TV by using the **SCART** sockets. *Note that cables shown in the illustration are not supplied.*

- Power off both the TV and the devices before making any connections.
- For more information, refer to your device's own instruction book.

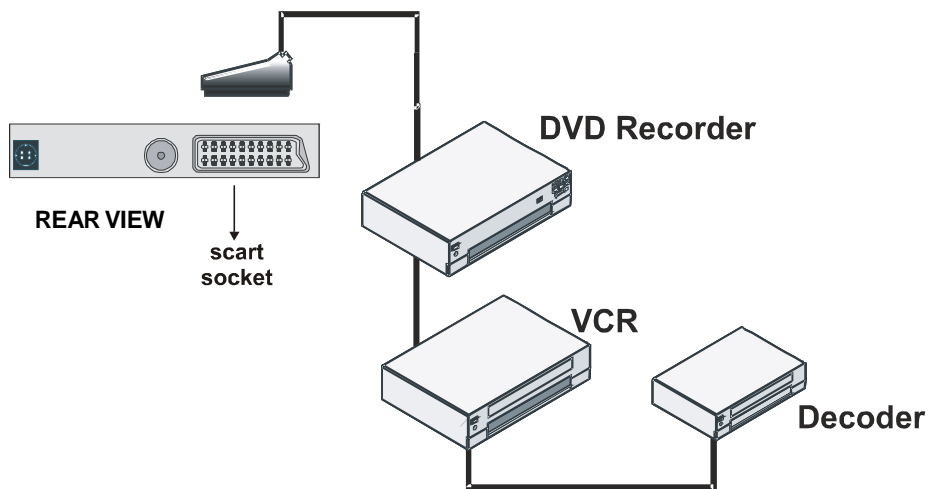

### Inserting Batteries in the Remote Control Handset

- Remove the battery cover located on the back of the handset by gently pulling backwards from the indicated part.
- Insert two **AAA/R03** or equivalent type batteries inside. Place the batteries in the right directions and replace the battery cover.

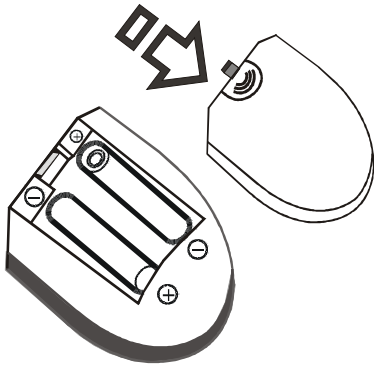

**Note:** Remove the battery from remote control handset when it is not to be used for a long period. Otherwise, it can be damaged due to any leakage of batteries.

### Operating Range for the Remote Control

- Point the top of the remote control toward the LCD TV's remote sensor LED while pressing a button.

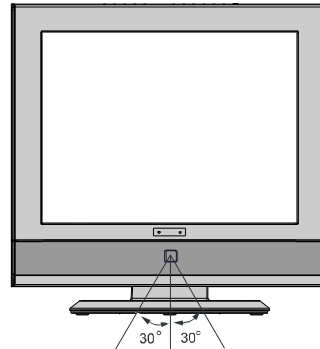

Remote range is approximately 7m/23ft.

## Switching the TV On/Off

### To Switch the TV On

Your TV will switch on in two steps:

- 1- Connect the power cord to the system.  
Press **Power On/Off** switch. Then the TV switches itself to stand-by mode (optional).
- 2- To switch on the TV from stand-by mode either:

Press a digit button on the remote control so that a programme number is selected.

or,

Press “**⏻**”, “**-P/CH**” or “**P/CH+**” button on the TV or press the “**⏻**”, “**- P**” or “**P+**” button on the remote control.

By either method the TV will switch on.

### To switch the TV off

- Press the “**⏻**” button on the remote control, so the TV will switch to stand-by mode.
- To power down the TV completely, press **Power On/Off** switch.

or,

- Unplug the power cord from the mains socket.

## Input Selection

Once you have connected external systems to your TV, you can switch to different input sources.

- Press the **AV** button on your remote control until the desired source is highlighted. The TV will then switch to the selected source after a short while.



- Depending on your selection of working mode, the remote control buttons' functions will change accordingly.

## Basic Operations

*You can operate your TV using both the remote control and onset buttons.*

### Operation with the Buttons on the TV Volume Setting

- Press **▲** - button to decrease volume or **▲ +** button to increase volume, so a volume level scale (slider) will be displayed on the screen.

### Programme Selection

- Press **P/CH +** button to select the next programme or **P/CH -** button to select the previous programme.

### Entering Main Menu

- Press the **MENU** button to enter main menu. In the Main menu select sub-menu using **P/CH -** or **P/CH +** buttons and enter the sub-menu using **▲** - or **▲ +** buttons. To learn the usage of the menus, refer to the menu system sections.

### AV Mode

- Press the **TV/AV** button at the control panel on the the TV to switch your TV to AV modes.

### Operation with the Remote Control

- The remote control of your TV is designed to control all the functions of the model you selected. The functions will be described in accordance with the menu system of your TV.
- Functions of the menu system are described in the following sections.

### Volume Setting

Press **V +** button to increase the volume. Press **V -** button to decrease the volume. A volume level scale (slider) will be displayed on the screen.

### Programme Selection (Previous or Next Programme)

- Press **P -** button to select the previous programme.
- Press **P +** button to select the next programme.

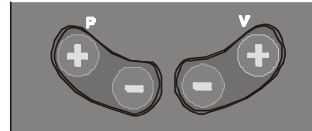

### Programme Selection (Direct Access)

- Press numeric buttons on the remote control to select programmes between 0 and 9. The TV will switch to the selected programme. To select programmes between 10 - 999 (for IDTV) or 10-99 (for analogue), press the numeric buttons consecutively (e.g. for programme 27, first press 2 and then 7). When the pressing time is due for the second numeric button, only the first digit programme will be displayed. The limit of the delay time is 3 seconds.
- Press directly the programme number to reselect single digit programmes.

## Initial Settings

When the TV set is operated for the first time, the IDTV turns on first.

Because this is the first time the TV is used, there are no channels stored in the memory and the following message appears on the screen:

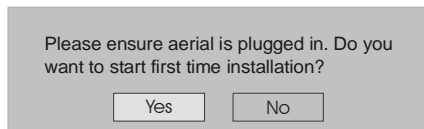

- To start installation process, select “**Yes**”, to cancel select “**No**”.
- To select the “**Yes**” or “**No**” option, highlight the item by using ◀ or ▶ buttons and press the **OK** button.

The IDTV will automatically tune to the UHF transmission channels 21 to 68, searching for digital terrestrial TV broadcasts and displaying the names of channels found. This process will take about five minutes. To cancel searching, you can press the **M** button at any time during the process.

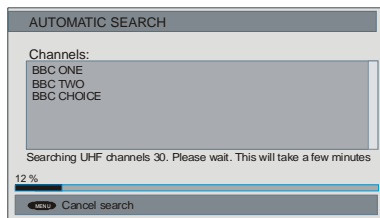

After **Automatic Search** is completed, the following message asking for analogue channel search appears on the screen:

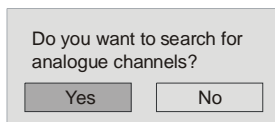

To search for analogue channels, select “**Yes**”. TV switches to the analogue TV mode. The menu below is displayed to search for analogue channels:

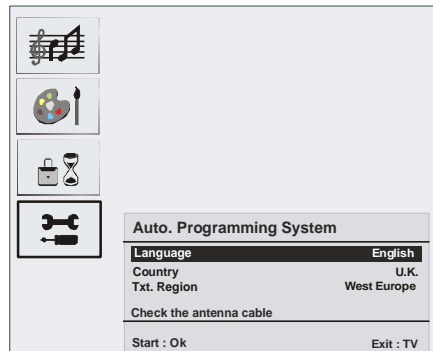

Set **Language** item by pressing ◀ or ▶ button. Press ▲ or ▼ button to highlight **Country** item and then use ◀ or ▶ to set. Press ▲ or ▼ button to highlight **Txt. Region**. Select a region by using ◀ or ▶ button. When finished, press **OK** button to continue. To cancel, press the **TV** button.

For more information on this process, see “**Install Menu**” section.

**NOTE:** For proper functioning of digital teletext in DTV mode, you should set **country** as UK in analogue APS.

## General Operation

Pressing the TV or DTV button at any time while watching television programmes will switch the TV set between displaying the digital terrestrial television broadcasting and its normal analogue broadcasting.

### Information Banner

- Whenever you change channel, using the **P-** / **P+** button or the numeric buttons, the TV displays the broadcast picture along with an information banner at the bottom of the screen. This will remain on the screen for approximately three seconds.
- The information banner can also be displayed at any time while watching TV by pressing the **i** button on the remote control:

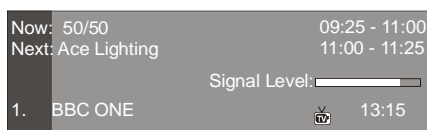

- The information banner gives information on the channel selected and the programmes on it. The name of the channel is displayed, along with its channel list number and an indication of the strength of the signal received.

**Hint:** Not all channels broadcast the programme data. If the name and time of the programme are not available, then **"No Information Available"** will be displayed in the information banner.

- Icons are also displayed in the information banner and if this channel is a favourite channel, favourite channel icon "😊" will also be displayed.

If the selected channel is locked, you must enter the correct four numeric code to view the channel. **"Enter Lock Key"** will be displayed on the screen in such a case:

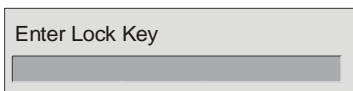

### Electronic Programme Guide (EPG)

- Some, but not all, channels send information about the current and next events.
- Please note that event information is updated automatically. If there is no event information data available in channels, only channel names with **"No Information Available"** banner is displayed.
- Press **GUIDE** button to view the **EPG** menu.
- In EPG menu, you can easily see the extended help information by pressing **i** button.
- Press this button again to close this window.
- In the EPG menu, all channels are displayed.

Current channel is highlighted. Use **▲** or **▼** buttons to change channels. Also press **GREEN/RED** buttons to scroll up/down the pages for the channels.

- If you highlight an event; short event description, extended event description, start and end times of the event will be displayed on the screen.
- When the current programme is highlighted, the box is switched to the highlighted channel by pressing the **OK** button.
- If you press the **OK** button when a next event is highlighted, a reminder is set for the highlighted programme and a clock appears across the highlighted channel line.

Programme reminders can be set to signal that a programme is about to start when you are watching another channel. If you set reminder for a programme, then you will be asked for switching to that channel when the reminder time is reached.

- Press the **M** button to view the 7 day EPG.
- Press **▲** or **▼** button to navigate in Channels or Programmes.
- Press **◀** or **▶** button to navigate through the channel and programme list.

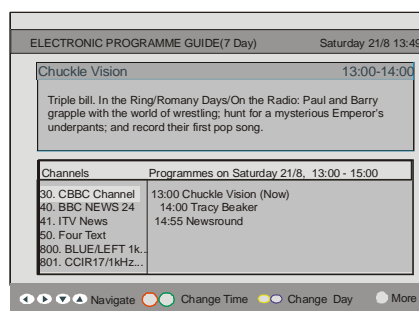

- With **RED/GREEN** buttons, you can change the schedule time. By pressing **YELLOW/BLUE** you can advance the schedule backward/forward of a day.

- If you press **i** button you can see the detailed help information easily. Press **i** button again to exit help menu.
- The starting time for **EPG** is the current time. You can see the event information for the next two hours. By pressing **▲** or **▼** button, you can go to the next/previous hours while Programmes list is highlighted.
- If you press the **OK** button when a next event is highlighted, a reminder is set for the highlighted programme and a clock appears on the screen.
- Programme reminders can be set to signal that a programme is about to start when you are watching another channel. If you set reminder to a programme, then you will be asked for switching to that channel when the reminder time is due.

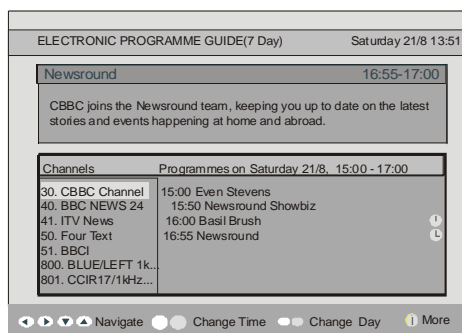

### Displaying the Subtitles

With digital terrestrial broadcasting (DVB-T), some programmes are broadcast with subtitles. Subtitles can be displayed while watching these programmes.

Press the **M** button to display the main menu, highlight the **Configuration** line using **▲** or **▼** button and press the **OK** button to display the configuration menu.

Highlight the **“Subtitle”** item in configuration menu and use **◀** or **▶** button to set Subtitle to Off or a language.

If **“Subtitle”** is on and a language option is set, pressing the **☰** button causes the following warning message display on the screen:

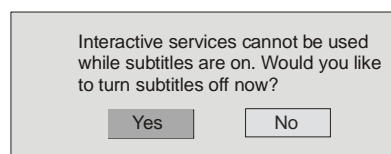

### Digital Teletext

With digital terrestrial broadcasting (DVB-T), in addition to pictures and sound, you can also view digital teletext.

Digital teletext is sometimes broadcast at the same time with the normal broadcasting.

- Press the **☰** button.
- The digital teletext information appears.
- Operate it with the coloured buttons, **◀/▶/▼/▲** buttons and **OK** button.

The operation method may differ depending on the contents of the digital teletext.

Follow the instructions displayed on digital teletext screen.

- When **“Press SELECT”** button or similar message appears on the screen, press the **OK** button.
- When the **☰** (Text) button is pressed, the TV returns to television broadcasting.
- With digital terrestrial broadcasting (DVB-T), in addition to digital teletext broadcasting at the same time with the normal broadcasting, there are also channels with just digital teletext broadcasting.
- The aspect ratio when watching a channel with just digital teletext broadcasting is the same as the aspect ratio of the picture watched previously.
- When you press the **☰** (Text) button again, the digital teletext screen will be displayed.

## Over Air Download

To ensure that your IDTV always has the most up-to-date information, please ensure that, after use, it is set to standby mode. At 3 A.M. each day, the IDTV automatically searches for any new information which may be broadcast and will download this to your IDTV automatically. This operation will normally take approximately 30 seconds.

If you want to perform this, you need to set Automatic Download to “**Enabled**” in Receiver Upgrade setting.

## Widescreen

Depending on the type of the broadcast being transmitted, programmes can be viewed in a number of formats. Press the **WIDE** button repeatedly to select between **Auto**, **4:3**, **16:9**, **Cinema** or **Subtitle**.

When **Auto** is selected, the format being displayed is determined by the picture being broadcast.

**PLEASE NOTE:** *Menu size changes depending on the chosen image size.*

## IDTV Menu System

The IDTV menu can only be viewed when watching digital terrestrial broadcasting. Press the DTV button to turn IDTV on while the TV is in analogue mode.

Press the **M** button. The menu below appears on the screen:

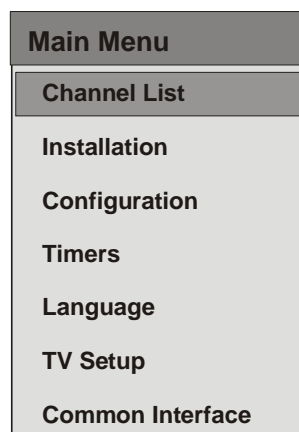

### Channel List

Using the **▲** or **▼** button on the remote control, make sure that the first item, Channel List, is highlighted and press the **OK** button to display the **Channel List**.

The following operations can be performed in this menu:

- Navigating the entire list of channels
- Deleting channels
- Renaming channels
- Adding locks to channels
- Setting favourites

Channel List is the place where the channels are managed.



### Navigating the Entire Channel List

Press ▲ or ▼ button for selecting the previous or next channel. You can press **RED** or **GREEN** button to move page up or page down.

To watch a specific channel, highlight it using ▲ or ▼ button and then press **OK** button, while the **“Select”** item on Channel List menu is highlighted by using ◀ or ▶ button.

Then the name and number of the selected channel will be displayed in the top-left and top-right of the channel display at the top-right of the screen, respectively.

### Deleting the Channels in the Channel List

Press ▲ or ▼ button to select the channel that will be deleted.

Press ◀ or ▶ button to select the **“Delete”** item on Channel List menu. As seen on Channel List menu, **SELECT** is displayed next to **Delete** item at the bottom of the screen to indicate that you must press the **OK** button to delete the highlighted channel in the channel list.



Press the **OK** button to delete the highlighted channel in the channel list. Then the message below appears on the screen:

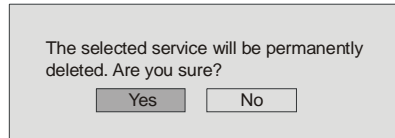

Press ◀ or ▶ button to highlight the desired option. If **OK** button is pressed while **“Yes”** is highlighted, the highlighted channel is deleted. Selecting **“No”** cancels the deletion.

### Renaming Channels

To rename a specific channel, the channel must be highlighted by pressing ▲ or ▼ button. Then highlight the **Edit Name** item by pressing ◀ or ▶ button as illustrated below. Press the **OK** button to activate the rename feature.



Now pressing ◀ or ▶ button moves to the previous/next character. Pressing ▲ or ▼ button toggles the current character, i.e., ‘b’ character becomes ‘a’ by ▼ and ‘c’ by ▲. Pressing the numeric buttons **‘0...9’** replaces the highlighted character with the characters printed above the button one by one as the button is pressed.

Press the **M** button to cancel the editing or **OK** button to save the new name.

### Adding Locks to Channels

Channel locking provides a password-

protected access to channels selected by parents. In order to lock a channel you should know the parental lock password (default value is set to 0000 in the factory and can only be changed from the **Configuration** menu).

Select the channel to be locked by highlighting it and select the **Lock** option by pressing ◀ or ▶ button. When the **OK** button is pressed, a dialog OSD asking for the password will be displayed.

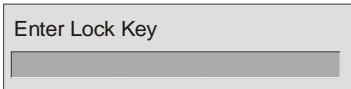
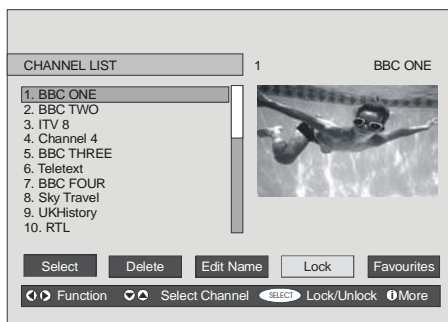

Enter the password by using the numeric buttons on the remote control. The lock icon “🔒” will now be displayed next to the selected channel. Repeat the same operation to cancel the lock.

### Setting Favourites

You can set various channels as favourites so that only the favourite channels are navigated. To set a favourite you should highlight the **Favourites** item at the bottom of the Channel List menu.

Use the ◀ or ▶ button to highlight the “**Favourites**” item at the base of the screen and then, in turn, highlight each channel you want to add to the favourites list, using the ▲ and ▼ buttons (or red/green buttons), and press the **OK** button.

A channel selected as a favourite appears in the main channel list with a favourites icon (😊) against the channel name as illustrated below:

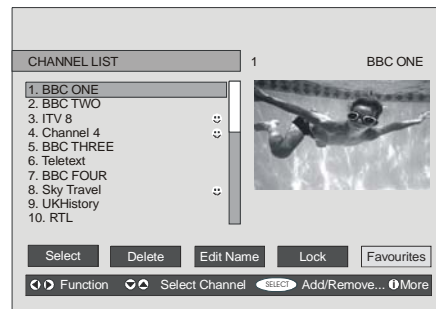

### On Screen Help

For all menus, press the ⓘ button to display the help information about the menu functions. For **Channel List** menu the following message is displayed on the screen:

Press the SELECT button on your remote control to tune to the highlighted channel.  
Press MENU to exit this screen.

### Installation

The Installation menu is mainly intended to help you for creating a **Channel Table** in the most efficient way.

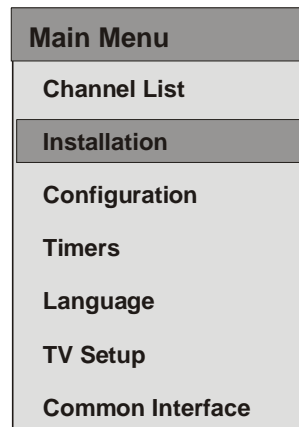

This menu includes the following items:

- Add New Channels.
- First Time Installation.

## Add New Channels

This tuning menu consists of two parts:

- Automatic Search
- Manual Search



### Automatic Search

Automatic search is started by pressing the **OK** button in the auto-search pop up menu. All the services will be searched and a channel table will be created automatically.

All channels found are stored in a sorted form with respect to their channel numbers. Some services may not appear with the correct channel number. If the broadcaster has no channel information, this may happen due to missing info.

### Manual Search

In manual search, the number of the multiplex is entered manually and only that multiplex is searched for the channels. For every valid channel number, signal level, signal quality and network name are shown at the bottom of the screen.

In both manual and auto search, any existing channel in the database is not re-stored to avoid redundant duplicates of that channel.

### First Time Installation

The user can use this item to load default settings, which were loaded to the receiver at the factory.

To install factory settings, highlight "**First Time Installation**" menu and press the **OK** button.

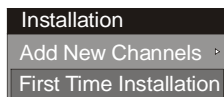

Then you will be asked to confirm for deleting all channels and settings:

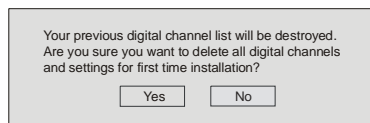

By selecting **Yes** and pressing the **OK** button, the existing channel table will be deleted.

After factory settings are loaded, "**First Time Installation**" menu will be displayed:

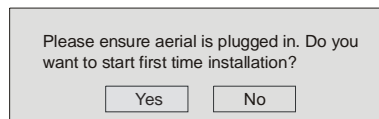

Press the **OK** button to start installation. After search is completed for digital channels, a message asking whether to search for analogue channels appears on the screen:

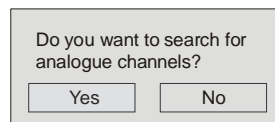

Press the **OK** button to search for analogue channels. The following menu appears on the screen for analogue channel search:

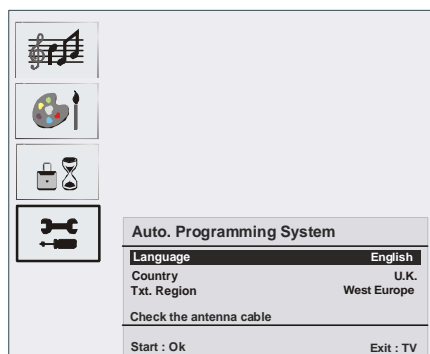

Set **Language** item by pressing **◀** or **▶** button. Press **▲** or **▼** button to highlight **Country** item and then use **◀** or **▶** to set. Press **▲** or **▼** button to highlight **Txt. Region**. Select a region by using **◀** or **▶** button. When finished, press **OK** button to continue. To cancel, press the **TV** button. The following menu will be displayed during the APS process:

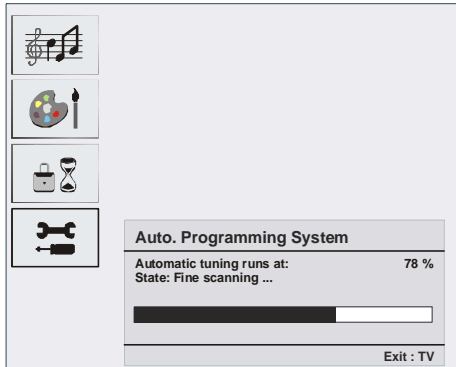

After APS is finalized, the programme table will appear on the screen. In the programme table you will see the programme numbers and names assigned to the programmes.

If you do not accept the locations and/or the programme names, you can change them in the programme table.

### Configuration

Press the **M** button to display the main menu and press the **▼** button twice to highlight Configuration. Then press the **OK** button to display the configuration menu. Press the **M** button to leave the menu screen.

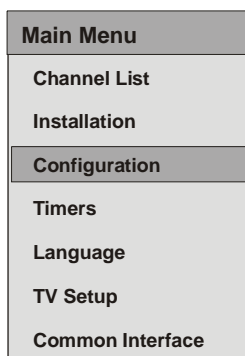

The various configuration functions are displayed in a list, along with a quarter-screen image of the currently selected channel. You can select a function by highlighting the corresponding menu line using the **▲** or **▼** button. Configuration menu will look like this:

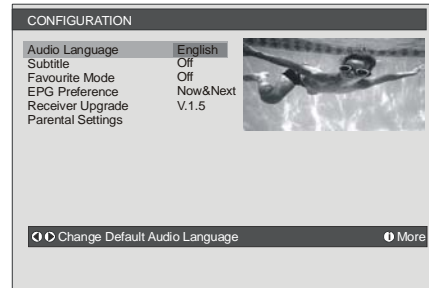

### Audio Language

Digital terrestrial television channels can broadcast simultaneous soundtracks in more than one language. This function selects which language soundtrack you will hear when switching to a channel broadcasting with the multiple soundtracks.

Highlight the **Audio Language** line in the **Configuration** menu and use the **◀** or **▶** button to cycle through the language options.

### Subtitle

Digital terrestrial television channels can broadcast subtitles displayed on the screen for hard-of-hearing people. This function selects the desired subtitle language and enables the automatic display of subtitles whenever subtitle information is broadcast.

Highlight the **Subtitle** line in the Configuration menu and use the **◀** or **▶** button to cycle through "Off" and language options.

### Favourite Mode

This function enables or disables the favourite channel list mode.

Use **◀** or **▶** button to turn on/off favourite mode. If the "Favourite Mode" is on; while in normal operating mode, pressing **P+** and **P-** buttons will only navigate through the channels that were previously defined as favourites in the channel list.

### EPG Preference

Digital terrestrial television channels can

broadcast simultaneous Next&Now and 7-Day electronic programme.

Highlight the EPG Preference line in the **Configuration** menu and use the ◀ or ▶ button to select **Next&Now** or **7-Day**.

### Receiver Upgrade

The IDTV can be upgraded via the configuration menu, entered from the main menu.

In the configuration menu, highlight the **“Receiver Upgrade”** item by pressing ▲ or ▼ button and press the **OK** button to start upgrade process.

There are two possibilities for receiver software to be upgraded: **automatic** and **manual**.

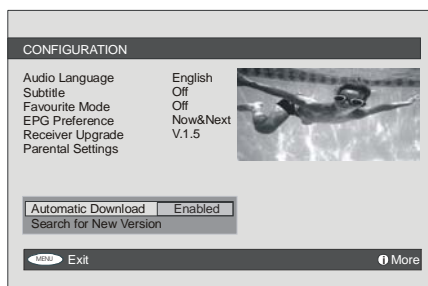

### Automatic Download (Automatic Upgrade)

Automatic Download can be enabled or disabled by pressing ◀ or ▶ button. If it is enabled, then there are two ways for automatic upgrade:

- The first one is checking the existence of a new software every time the IDTV goes to standby.
- The second one is being activated at 03:00 A.M. every night, provided that the IDTV is left in standby mode.
- Both automatic upgrade methods result in standby mode either the upgraded or not.

If the automatic upgrade is set to **“Disabled”** then this function will not work.

### Search for New Version (Manual Upgrade)

Manual upgrade starts if the **“Search for New Version”** item is highlighted by using ▲ or ▼ button and activated via pressing the **OK** button.

After **“Search for New Version”** is activated, the IDTV tunes to each frequency that have been stored in its database and looks for the new software. During this process, the following OSD is displayed:

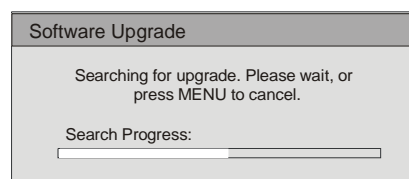

### Parental Settings

Some channels broadcast material which you do not want younger members of the family to watch. Any channel can be 'locked' so that it cannot be selected for viewing unless a four-digit PIN code is entered. In this way, any channel not suitable for younger viewers can be prohibited.

This function enables or disables the menu protection system and allows the PIN code to be changed.

Use ▲ or ▼ button to highlight **Parental Settings** option. Press the **OK** button to enter Parental Settings menu. A dialog box asking for the lock key is displayed:

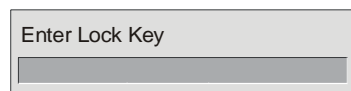

There is only one key which is set to **“0000”** initially. Enter lock key. If wrong lock key is entered, the following message is displayed and the TV then returns to the previous menu:

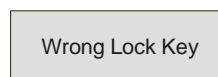

If it is correct, the **Parental Settings** menu will be displayed including the following items:

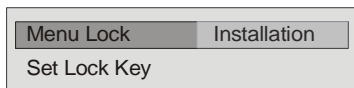

There you can set/reset locking for the main menu or the installation menu to restrict access. If the menu lock is disabled, there will be free access to the menu system. Also in this menu you can change the lock key and set/change parental lock mode.

**Disabled:** All menus are unlocked.

**Main Menu:** Main menu is accessible only with the correct lock key. So the user cannot add, delete, rename, move channels, cannot set timers.

**Installation:** Installation menu is locked, so the user cannot add channels.

**Note:** Changes will be updated after exiting configuration menu.

## Timers

You can set a timer to switch the TV to any channel without your intervention. This is also for making video recordings of programmes when you are out.

Display the main menu by pressing the **M** button. Highlight the **Timers** line by pressing **▲** or **▼** button and press the **OK** button to display the Timer menu:

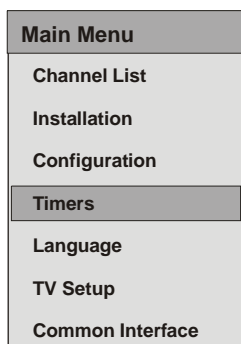

Up to five separate timer events can be set and each is displayed in the Timer screen, showing the event number, the channel to be selected, the start time, end time, date and the mode - whether that event is active (and will be acted on) or not.

No	Channel Name	Start	End	Date	Mode
1.	ITV 1	20:00	21:00	12/05/2005	Active
2.	BBC ONE	00:00	00:00	01/01/2005	Inactive
3.	BBC ONE	00:00	00:00	01/01/2005	Inactive
4.	BBC ONE	00:00	00:00	01/01/2005	Inactive
5.	BBC ONE	00:00	00:00	01/01/2005	Inactive
6.	BBC ONE	00:00	00:00	01/01/2005	Inactive

- To set an event, highlight its mode button using the **▲** or **▼** button and press the **OK** button to display the timer entry window.

Name:	3. ITV 1
Start:	00:00
End:	00:00
Date:	03/06/2005
Mode:	Once

- Here the five settings consisting of the channel name, start time, end time, date and frequency mode can be set. You can move freely between each setting using the **▲** or **▼** buttons.
- The channel name is set using the **◀** or **▶** button to display the channel which broadcasts the programme.
- The start time, end time and date are each set with the numeric buttons on the remote control in 24-hour format.
- The frequency mode determines how often the receiver operates this event and is set with the **◀** or **▶** button to be either **Once**, **Daily**, or **Weekly**.

If an invalid number for the start or end times or the date is entered, “**Entered time is not valid**” message appears on the menu screen.

If timer action occurs while the TV is being watched, the TV switches to the selected channel. When timer expires, the TV switches back to the channel which it is switched from. Selected digital channel will be output via Scart-2. You should connect your VCR to Scart-2 for recording digital broadcast.

### Language

Some programmes are broadcast in two or more languages simultaneously. The language thus can be selected from the Language menu.

- Press the **M** button to display the main menu and use **▲** or **▼** button to highlight the Language line and press the **OK** button:

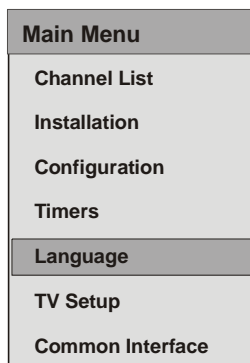

- Use the **▲** or **▼** button to highlight the soundtrack language required and press the **OK** button. Normal viewing, with the required language soundtrack, can be resumed by pressing the **M** button.

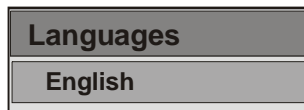

### TV Setup

You can use this item to display the TV functions.

The digital TV Setup menu screen is accessed from the main menu. Press the **M** button to display the main menu and use **▲** or **▼** button to highlight “**TV Setup**”, press the **OK** button to display TV Setup menu screen.

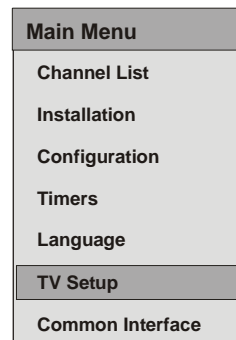

You can find detailed information for all menu items in “Analogue TV Menu System” section.

### Common Interface

- Press the **M** button to display the main menu and use the **▲** or **▼** button to highlight the “**Common Interface**” line and press the **OK** button:

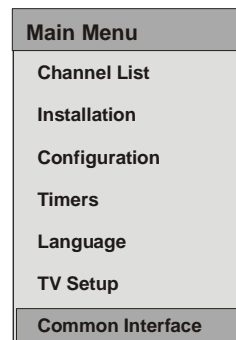

It is required to subscribe to a pay channel company to view the pay channels of the digital terrestrial broadcasting.

Obtain the Conditional Access Module (CAM) and the viewing card by subscribing to a pay

channel company, then insert those to the TV using the following procedure.

- Switch off the TV and unplug from the mains.
- Insert the CAM, then viewing card to the slot that is located in the terminal cover at the left-hand side of the TV (from front view).
- The CAM should be correctly inserted, it is impossible to insert fully if reversed. The CAM or the TV terminal may be damaged if the CAM is forcefully inserted.
- Connect the TV to the mains supply, switch on and then wait for few moments until the card is activated.
- Some CAMs may require the following set up. Please set the CAM by entering the IDTV menu, Common Interface then pressing the **OK** button. (CAM set up menu is not displayed when it is not required.)
- To see the viewing contract information: enter IDTV; press the **M** button, then highlight **Common Interface** and press the **OK** button.
- When no module is inserted, "**No Common Interface module detected**" message appears on the screen.
- Refer to the module instruction manual for details of the settings.

**NOTE:** Insert or remove the CI module only when the TV is in **STAND-BY** mode or **SWITCHED OFF**.

## Navigating the Analogue TV Menu System

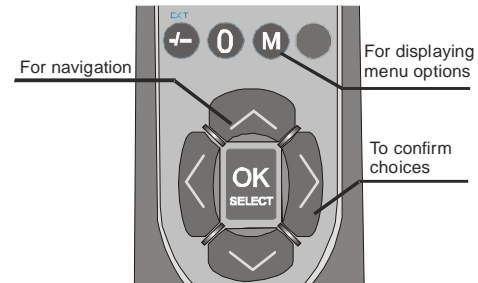

- Press **M** to display the main menu.
- Press **▲** or **▼** button to select an icon. Press **▶** or **OK** button for more options.
- Use **▲** or **▼** button to highlight.
- Press **◀** or **▶** buttons to change the settings. Press **OK** to set as default.
- To exit the menu or return from sub-menu screen, press **M**.

**Note:** These explanations are valid for the navigation of the whole menu system. To select options that are explained in the following parts, refer to "Navigating the Analogue TV Menu System".

## Analogue TV Menu Map

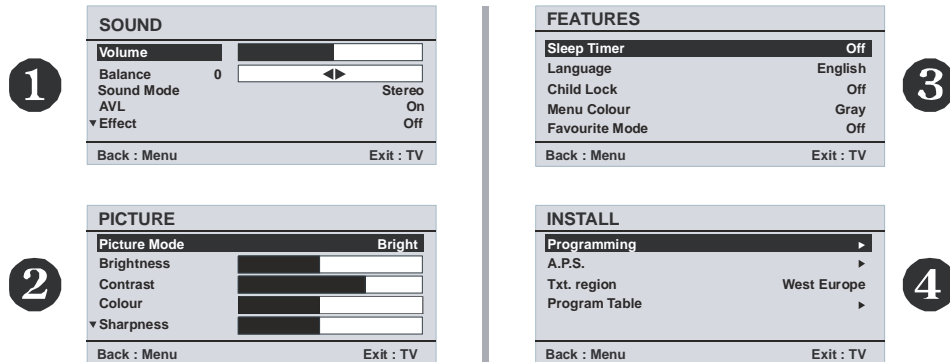

### 1 SOUND MENU

- Volume
- Balance
- Sound Mode
- AVL
- Effect
- Equalizer
- Mode
- HP Volume
- Store

### 2 PICTURE MENU

- Picture Mode
- Brightness
- Contrast
- Colour
- Sharpness
- Colour Temp
- Room Lighting
- Picture zoom
- Store

### 3 FEATURES MENU

- Sleep Timer
- Language
- Childlock
- Menu Colour
- Favorite Mode

### 4 INSTALL MENU

- Programming
- Programme
- Band
- Channel
- Standard
- Colour System
- Search
- VCR Mode
- Decoder
- Store
- APS
- Auto Programming System
- Txt. Region
- Program Table

*A menu map is provided above. For details of the items, refer to relevant explanations in the "MENU SYSTEM".*

## Analogue TV Menu System

### Sound Menu

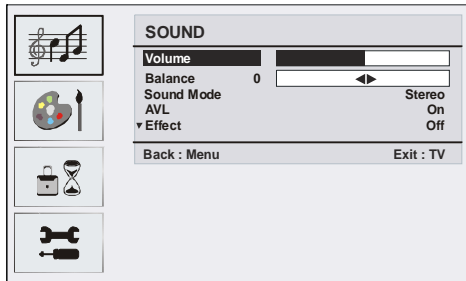

#### Volume

When you enter the sound menu, Volume will be the first selected option. Press ◀ / ▶ button to change the level of the Volume.

#### Balance

This setting is used for emphasizing the left or right speaker balance.

Press ▲ or ▼ button to select **Balance**. Press ◀ / ▶ button to change the level of the balance. Balance level can be adjusted between **-32** and **+ 32**.

#### Sound Mode

Press ▲ or ▼ button to select **Sound Mode**. Using ◀ / ▶ button, you can select **Mono**, **Stereo**, **Dual I** or **Dual II** mode, only if the selected channel supports that mode.

#### AVL

Automatic Volume Limiting (AVL) function adjusts the sound to obtain fixed output level between programmes (For instance, volume level of advertisements tends to be louder than programmes). For getting a better sound quality, it is recommended that you set AVL function as On.

Press ▲ or ▼ button to select **AVL**. Press ◀ / ▶ button to set the AVL as On or Off.

#### Effect

If you are watching a mono broadcast, set

**Effect** on to obtain a better sound effect which will be more stereo-like. If the current sound system is stereo, switching this effect on will give a more spatial effect.

Press ▲ or ▼ button to select **Effect**. Press ◀ / ▶ button to set **Effect** as On or Off.

#### Equalizer

Press ▲ or ▼ button to select **Equalizer**. Press ◀ / ▶ button to change the Equalizer setting. In equalizer menu, the mode can be changed to **Flat**, **Speech**, **Music**, **Personal** and **Jazz**. Select the desired frequency by pressing ▼ / ▲ button and increase or decrease the frequency gain by pressing ◀ / ▶ button.

*Note: Equalizer menu settings can be changed only when the mode is in Personal.*

#### HP Volume

To adjust headphone volume level, press ▲ or ▼ button to select **HP Volume**. Press ◀ / ▶ button to change the level of the HP Volume.

#### Store

Select **Store** by pressing ▲ / ▼ button. Press ▶ or **OK** button to store the settings. "**Stored**" will be displayed on the screen.

### Picture Menu

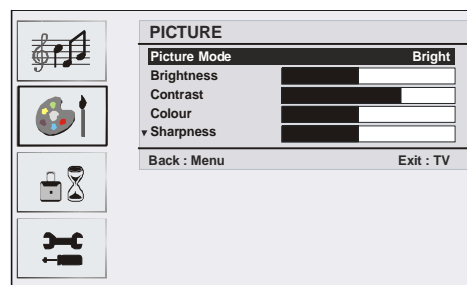

#### Picture Mode

For your viewing requirements, you can set the related **mode** option.

Press ▲ or ▼ button to select **Picture Mode**. Press ◀ or ▶ button to choose from one of these options: **Bright**, **Standard**, **Soft** and **Manual**.

## Brightness/Contrast/Colour/ Sharpness/Tint

Press ▲ or ▼ button to select the desired option. Press ◀ / ▶ button to set the level.

*Hint: Tint (Hue) is displayed in picture menu when the TV receives an NTSC signal.*

## Colour Temp

Press ▲ or ▼ button to select **Colour Temp**. Press ◀ / ▶ to choose from one of these options: **Cool**, **Normal** and **Warm**.

### Note:

- Setting **Cool** option gives white colours a slight blue stress.
- Setting **Warm** option gives white colours a slight red stress.
- For normal colours, select **Normal** option.

## Room Lighting

Select **Room Lighting** by pressing the ▼ / ▲ button. Press ◀ / ▶ button to set Room Lighting as **Normal**, **Bright** or **Movie**.

## Picture Zoom

Picture Zoom setting enables you to select the aspect ratio of the broadcast.

Select **Picture Zoom** by pressing ▼ / ▲ button. Use ◀ / ▶ buttons to change Picture Zoom to **Auto**, **4:3**, **16:9**, **Cinema** or **Subtitle**.

## Store

Select **Store** by pressing ▲ / ▼ button. Press ▶ or **OK** button to store the settings. “**Stored**” will be displayed on the screen.

## Features Menu

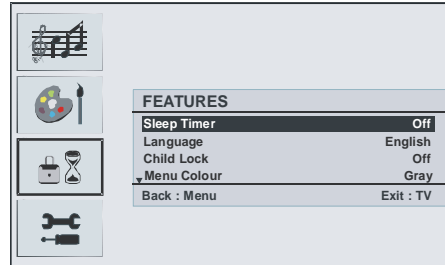

## Sleep Timer

Press ▲ or ▼ button to select **Sleep Timer**. Use ◀ / ▶ button to set the **Sleep Timer**.

The timer can be programmed between **Off** and **120** minutes in steps of 10 minutes.

If **Sleep Timer** is activated, at the end of the selected time, the TV goes automatically to standby mode.

## Language

Press ▲ or ▼ button to select **Language**. Use ◀ / ▶ button to select the **Language**.

## Child Lock

Press ▲ or ▼ button to select **Child Lock**.

Use ◀ / ▶ button to set the Child Lock **On** or **Off**. When **On** is selected, the TV can only be controlled by the remote control handset. In this case the control panel buttons (except for the **STANDBY** button) will not work.

Hence, if one of those buttons is pressed, “**Child Lock On**” will be displayed on the screen when the menu screen is not visible.

## Menu Colour

Press ▲ or ▼ button to select **Menu Colour**. Use ◀ / ▶ button to change menu background to **Transparent** or **Gray**.

## Favourite Mode

Press ▲ or ▼ button to select **Favourite Mode**.

Use ◀ / ▶ button to set Favourite mode **On** or **Off** (See the “Program Table” section for details).

## Install Menu

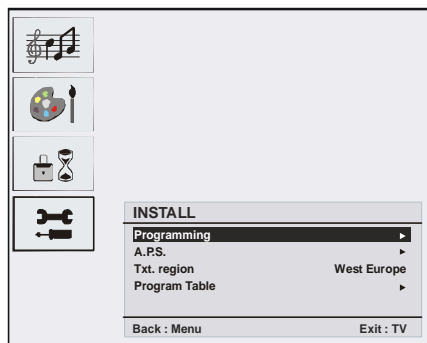

## Programming

Select **Programming** by pressing ▼ / ▲ button. Then press ► button to display Programming menu:

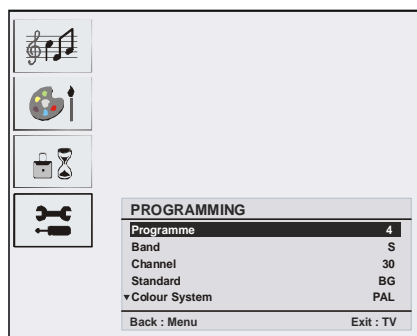

## Programme

Select **Programme** by pressing ▼ / ▲ button. Press ◀ / ▶ button to select the programme number. You can also enter a number via the numeric buttons on the remote control. There are 100 programme storage between 0 and 99.

### Band

Band can be selected either **C** or **S**. Press ◀ / ▶ button to select **Band**.

### Channel

Select **Channel** by pressing ▼ / ▲ button. Channel can be changed by pressing ◀ / ▶ button or the numeric buttons.

## Standard

Select **Standard** by pressing ▼ / ▲ button. Use ◀ / ▶ button to change the standard to **B/G**, **D/K**, **I** or **L/L'**.

## Colour System

Select **Colour System** by pressing ▼ / ▲ button. Use ◀ / ▶ button to change the colour system to **PAL**, **SECAM** or **AUTO**.

## Search

Select **Search** by pressing ▼ / ▲ button. Press ◀ / ▶ button to start search. The search will stop when a signal is found.

***Note:** If you press the buttons with one-step moves, a frequency of 0.25 Mhz will be advanced. However if you press the buttons all at once, it will advance automatically. To stop searching at a certain time, you may press ▼ / ▲ buttons.*

## VCR Mode

Select **VCR Mode** by pressing ▼ / ▲ button. Use ◀ / ▶ buttons to set VCR Mode as On or Off.

***Hint:** If you want to watch a DVD , then you have to set this item as **Off**.*

## Decoder

You can use this mode to connect any decoder to your TV.

Select **Decoder** by pressing ▼ / ▲ button. Press the ◀ / ▶ buttons to turn it On or Off.

When you switch the Decoder setting to **Off**, **EXT-1** output will be muted. In this case, **EXT-1** output will not be available to display video. If it is switched on, the **EXT-1** output will be the selected video source. Any decoder can be connected to **EXT-1** to unscramble required video signals.

***Hint:** Decoder setting should be stored separately for each programme.*

## Store

Select **Store** by pressing ▲ / ▼ button. Press ► or **OK** button to store the settings. "**Stored**" will be displayed on the screen.

## A.P.S.

Select **A.P.S.** by pressing  $\blacktriangle$  /  $\blacktriangledown$  button. Press  $\blacktriangleright$  button to enter the **A.P.S.** submenu:

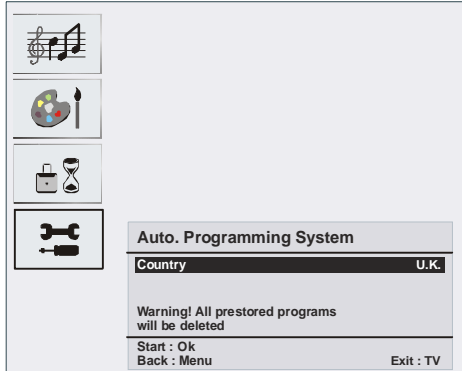

### A.P.S. Country

Press  $\blacktriangleleft$  /  $\blacktriangleright$  button to set your country.

If you want to exit from A.P.S. function, press the **TV** button. For going back, press **M**.

When you press **OK** button for starting APS, all stored programs will be erased and the following screen will be displayed:

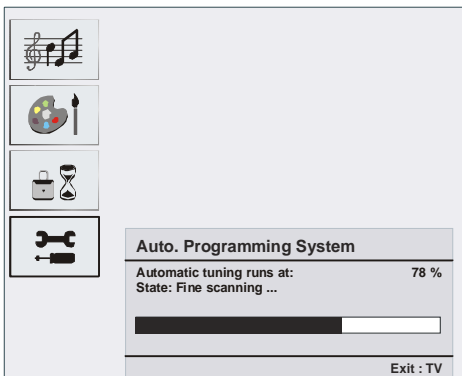

Whenever you press the **TV** button, A.P.S. function stops and program table appears on the screen.

If you wait until the end of A.P.S., Program Table is displayed with the programmes found and located.

## Teletext Region

Select **Txt. region** by pressing  $\blacktriangle$  /  $\blacktriangledown$  button. Using  $\blacktriangleleft$  /  $\blacktriangleright$  buttons, select your teletext region. There are five options to select: **West Europe, East Europe, Turk/Gre, Cyrillic** and **Arabic/Hebrew**.

### Install menu in AV modes

The following screen appears in the install menu:

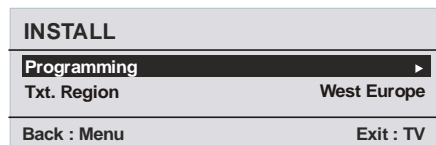

### Programming

Select **Programming** by pressing  $\blacktriangle$  /  $\blacktriangledown$  button. After pressing  $\blacktriangleright$  button, programming menu appears on the screen:

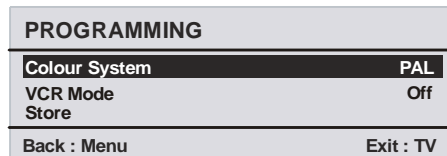

### Colour System

Select **Colour System** by pressing  $\blacktriangle$  /  $\blacktriangledown$  button. Press  $\blacktriangleleft$  /  $\blacktriangleright$  button to change the colour system to **PAL, SECAM** or **AUTO**.

### Program Table

Program Table		P01
P01	BBC 1	P11 .....
P02	C 04	P12 .....
P03	.....	P13 .....
P04	.....	P14 .....
P05	.....	P15 .....
P06	.....	P16 .....
P07	.....	P17 .....
P08	.....	P18 .....
P09	.....	P19 .....
P10	.....	P20 .....

Delete	Move
Name	A.P.S

Exit: TV

Program Table lists the channels that are stored in the memory. By moving the cursor in four directions, you can reach 20 programmes in the same page. You can scroll up or scroll down to see all the programmes while in TV mode by pressing the navigation buttons. By cursor action, programme selection is done automatically.

#### Name

To change the name of a programme, select the desired programme and press the **YELLOW** button.

The first letter of the selected name starts to blink. Press **▲ / ▼** button to change that letter and **◀ / ▶** button to select the other letters. By pressing the **YELLOW** button, you can store the name.

#### Move

Select the programme that you want to insert by using the navigation buttons. Press the **GREEN** button. Using navigation buttons, move the selected programme to the decided programme space and press the **GREEN** button again.

#### Delete

To delete a programme, press the **RED** button. Pressing the **RED** button again erases the selected programme from the programme list and the programmes below shift one line up.

#### APS (Auto Programming System)

When you press the **BLUE** button for APS, **Auto Programming System** menu will appear on the screen.

#### Favourite Mode

You can set various channels as favourites so that only the favourite channels are navigated. To set a favourite, use the navigation buttons to select a channel and then press the **☰** item. The channel selected as a favourite appears in the Program Table with a

favourites icon (☺) against the channel name. For removing a favourite, carry out the same operation. To exit, press **M**.

#### Program Lock

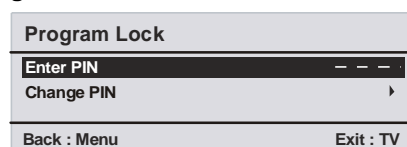

Program Locking provides a password-protected access to channels selected by parents. In order to lock a channel you should know the Program Lock password (default value is set to **0000** in the factory and can only be changed from the **Program Lock** menu).

#### Enter PIN

Select the channel that you desire to lock by highlighting it and then press the **☰** button. When the **☰** button is pressed, Program Lock menu will be displayed on the screen. After entering the pin code, desired channel will be locked. The program lock icon will appear next to the channel name. When the locked channel is selected through **P+** or **P-** buttons, the following warning screen will be displayed:

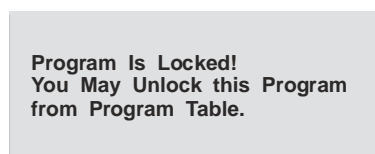

#### Change PIN

Select **Change PIN** by pressing **▼ / ▲** button. Use **▶** button to change the PIN code. After pressing **▶** button, the following message appears on the screen:

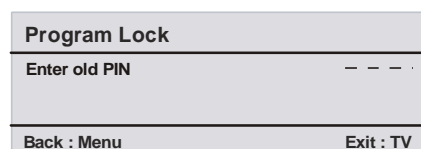

Enter old PIN code through the numeric buttons and then enter your new PIN code. Program Lock menu will be displayed on the screen when you enter the new PIN code:

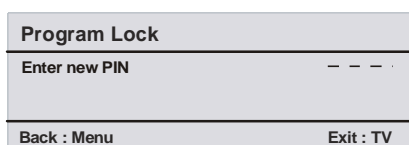

*Program Lock Menu will again be displayed after a short while of the identification of new PIN.*

*Hint: If you forget your Program Lock password, you can deactivate the Program Lock by using the code 7910 and be able to set new password for future use. Thus, do keep this code in a safe place for future reference.*

## Displaying TV Information

**Programme Number, Programme Name, Sound Indicator** and **Zoom Mode** information are displayed on the screen when a new programme is entered or **i** button is pressed.

## Mute Function

Press **Mute** button to disable sound. Mute indicator will be displayed in the upper side of the screen.



To cancel mute, there are two alternatives; the first one is pressing the **Mute** button and the second one is increasing the volume level.

## Personal Preference

Press **PP** button to adopt the previous settings that you had stored before.

## Zoom Modes

You can change the aspect ratio of the TV for viewing the picture in different zoom modes.

Press **WIDE** button to directly change the zoom mode. Available zoom modes are listed below:

### Auto

When a **WSS (Wide Screen Signalling)** signal, which shows the aspect ratio of the picture, is included in the broadcast signal or the signal from an external device, the TV automatically changes the **ZOOM** mode according to the **WSS** signal.

- When the **AUTO** mode does not function correctly due to poor **WSS** signal quality or when you want to change the **ZOOM** mode, change to another **ZOOM** mode manually.

### 4:3

Use to view a normal picture (4:3 aspect ratio) as this is its original size.

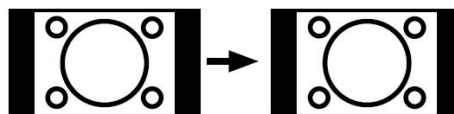

### 16:9

This uniformly stretches the left and right sides of a normal picture (4:3 aspect ratio) to fill the wide TV screen.

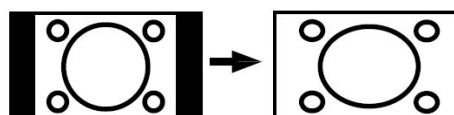

- For 16:9 aspect ratio pictures that have been squeezed into a normal picture (4:3 aspect ratio), use the **16:9** mode to restore the picture to its original shape.

## Cinema

This zooms up the wide picture (16:9 aspect ratio) to the full screen.

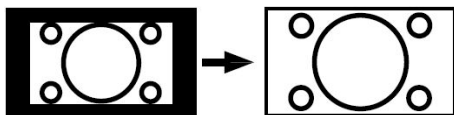

## Subtitle

This zooms up the wide picture (16:9 aspect ratio) with subtitles to the full screen.

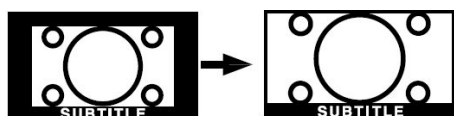

## Teletext

Teletext system transmits information such as news, sports and weather on your TV. Note that if the signal becomes insufficient, some text errors may occur or the teletext mode may be quitted.

*Teletext function buttons are listed below:*

### Teletext On-Off / PAT mode

Activates teletext mode when pressed once. Pressing this button again will split the screen into two windows, one displaying the teletext and the other displaying the current channel. Pressing again will quit the teletext mode.

### Index

Selects the teletext index page.

### Mix

Places the teletext screen over the programme.

### Expand

Press once to enlarge top half of the page, press again to enlarge the bottom half of the page. Press again to revert back to normal size.

### Reveal

Shows hidden information (e.g. solutions of games).

### Hold

Holds a text page when convenient. Press again to resume.

### Subcode Pages / Time

Selects subcode pages if available when the teletext is activated. When the teletext is not activated, displays time info if the programme has teletext transmission.

### P+ / P- and numbers (0-9)

Press to select a page.

**Note:** Most TV stations use code **100** for their index pages.

### Coloured Buttons

#### (RED/GREEN/YELLOW/BLUE)

Your TV supports both **FASTTEXT** and **TOP text** systems. When these systems are available, the pages are divided into groups or topics.

When **FASTTEXT** system is available, sections in a teletext page will become colour-coded and can be selected by pressing the coloured buttons. Press a coloured button that corresponds to with your needs.

The coloured writings will appear, showing you, which coloured buttons to use when **TOP text** transmission is present. Pressing **P -** or **P +** commands will request the next or previous page respectively.

## Tips

### Screen Care

Clean the screen with a slightly damp, soft cloth. Do not use abrasive solvents as they may damage the coating layer of the TV screen.

For your safety, unplug the mains plug when cleaning the set. When moving the TV, hold it properly from the bottom part.

### Image Persistence

Please note that ghosting may occur while displaying a persistent image. LCD TVs' image persistence may disappear after a short time. Try turning off the TV for a while.

To avoid this, do not leave the screen in still picture for extended periods.

### No Power

If your TV system has no power, please check the main power cable and connection to the mains socket outlet.

### Poor Picture

Have you selected the correct TV system? Is your TV set or house aerial located too close to a non-earthed audio equipment or neon lights, etc.?

Mountains or high buildings can cause double pictures or ghost images. Sometimes you can improve the picture quality by changing the direction of the aerial.

Is the picture or teletext unrecognisable? Check if you have entered the correct frequency.

The picture quality may degrade when two peripherals are connected to the TV at the same time. In such a case, disconnect one of the peripherals.

### No Picture

Is the aerial connected properly? Are the plugs connected tightly to the aerial socket? Is the aerial cable damaged? Are suitable plugs used to connect the aerial? If you are in doubt, consult your dealer.

**No Picture** means that your TV is not receiving a transmission. Have you selected the correct button on the remote control? Try once more.

### Sound

You cannot hear any sound. Did you perhaps interrupt the sound, pressing the  button?

Sound is coming from only one of the speakers. Is the balance set to one extreme? See **Sound** menu.

### Remote Control

Your TV no longer responds to the remote control. Perhaps the batteries are exhausted. If so you can still use the local buttons at the bottom of the TV.

### Input Sources

If you cannot select an input source, it is possible that no device is connected.

Check the AV cables and connections if you have tried to connect a device.

### CI Module

If you are experiencing a problem with the CI module, it is possible that CI module is not properly inserted. Remove the CI card and then reinsert.

If the problem persists, it is possible that your CI module is not recognized. Try inserting a different CI module.

## Specifications

### TV BROADCASTING

PAL/SECAM B/G D/K K' I/I' L/L'

### RECEIVING CHANNELS

VHF (BAND I/III)

UHF (BAND U)

HYPERBAND

CABLE TV (S1-S20 / S21-S41)

### NUMBER OF PRESET CHANNELS

100

### CHANNEL INDICATOR

On Screen Display

### RF AERIAL INPUT

75 Ohm (unbalanced)

### OPERATING VOLTAGE

220-240V AC, 50 Hz.

### AUDIO

German + Nicam Stereo

### AUDIO OUTPUT POWER ( $W_{RMS.}$ ) (10% THD)

2x2W

### POWER CONSUMPTION (W)

40W (max)

Less than 1W (Standby)

### PANEL

4:3 display, 15" Screen Size

### DIMENSIONS (mm)

DIMENSIONS (mm)				
D	L	H	Weight (kg)	
125	379	373	4.2	With stand
75	379	339	4.1	Without stand

## Pin Specifications

### SCART connector pin specifications

Pin	Input signal	Pin	Input signal
1	AUDIO OUT (RIGHT)	12	Not used
2	AUDIO IN (RIGHT)	13	RGB-R GND
3	AUDIO OUT (LEFT/MONO)	14	GND
4	AUDIO GND	15	RGB-R / S.VHS CHROMINANCE IN
5	RGB-B GND	16	BLANKING SIGNAL
6	AUDIO IN (LEFT/MONO)	17	COMPOSITE VIDEO GND
7	RGB-B IN	18	BLANKING SIGNAL GND
8	AUDIO / RGB SWITCH / 16:9	19	COMPOSITE VIDEO OUT
9	RGB-G GND	20	COMPOSITE VIDEO / S.VHS LUMINANCE IN
10	Not used	21	GND / SHIELD (CHASSIS)
11	RGB-G IN		

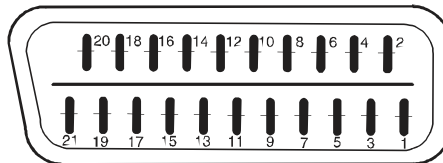

## Important Instruction

For your own safety read following instruction carefully before attempting to connect this unit to the mains supply.

### MAINS (AC) OPERATION

The wires in the mains lead are coloured in accordance with the following code :

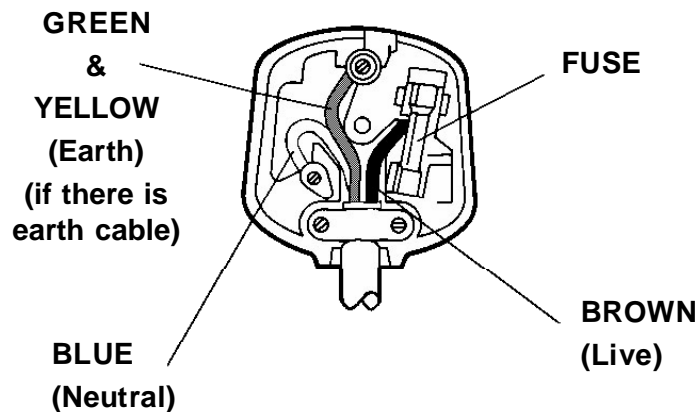

### IMPORTANT

As the colours of the wires in the mains lead of this appliance may not correspond with the coloured markings identifying the terminals in your plug, proceed as follows:  
The Green and Yellow coloured wire must be connected to the terminal which is marked with the letter E, or by the earth symbol, or with Green or Green and Yellow colors.

The Blue or Black coloured wire must be connected to the terminal which is marked with the letter N or black colour.

The Brown or Red coloured wire must be connected to the terminal which is marked with the letter L or Red colour.

For continued protection against risk of fire, replace only with a fuse with the same type and rating. (ASTA approved 5A 250VAC fuse).

### CAUTION

TO PREVENT ELECTRIC SHOCK DISCONNECT FROM THE MAINS BEFORE REMOVING COVER. NO USER SERVICEABLE PARTS INSIDE. REFER SERVICING TO QUALIFIED SERVICE PERSONNEL.

### SAFETY PRECAUTION

THIS DEVICE MUST BE DISCONNECTED FROM THE MAINS WHEN NOT IN USE. DO NOT ALLOW THIS UNIT TO BE EXPOSED TO RAIN OR MOISTURE.

## Contents

<b>General Properties</b> .....	<b>43</b>	<b>Troubleshooting</b> .....	<b>55</b>
<b>About this Manual</b> .....	<b>43</b>	The picture quality is poor (DVD) .....	55
Safety Information .....	43	Disc does not play .....	55
<b>Notes on Discs</b> .....	<b>44</b>	Wrong OSD language .....	55
<b>DVD Control Panel Buttons</b> .....	<b>44</b>	The language for the sound or subtitles on a DVD cannot be changed.....	55
<b>Remote Control Buttons</b> .....	<b>45</b>	Some functions (Angle, Zoom etc) do not work .....	55
<b>Disc Types Compatible with This Unit</b> .....	<b>46</b>	No picture .....	55
<b>DVD Playback</b> .....	<b>47</b>	No sound .....	55
Rapid Advance (Rapid Reverse) .....	47	Distorted sound .....	55
Skipping Ahead or Back to Chapters .....	47	No response from remote control .....	55
Still Picture (PAUSE) .....	47	If nothing works .....	55
Frame Advance (STEP FORWARD) .....	47	<b>Definition of Terms</b> .....	<b>56</b>
Slow- motion Play Forward .....	47	Angle .....	56
Direct Selection of Scenes .....	47	Chapter Number .....	56
Repeat Play .....	48	DVD .....	56
Convenient Functions .....	48	Playback Control .....	56
<b>Using a DVD Menu</b> .....	<b>50</b>	Subtitles .....	56
<b>Video CD Playback</b> .....	<b>50</b>	Time Number .....	56
Basic Play .....	50	Title Number .....	56
Rapid Advance / Rapid Reverse .....	51	Track Number .....	56
Skipping Ahead or Back to Chapters .....	51	Video CD .....	56
Still Picture (PAUSE) .....	51	Dolby Digital .....	56
Frame Advance (STEP Forward) .....	51	Dolby Pro Logic .....	56
Slow- motion Play .....	51	LPCM .....	56
Direct Selection of Scenes .....	51	MPEG .....	56
Repeat Play .....	51	<b>Specifications</b> .....	<b>57</b>
Convenient Functions .....	52		
<b>CD Menu</b> .....	<b>52</b>		
Basic Play .....	52		
Pause .....	52		
Stopping Play .....	52		
Skipping Ahead or Back to Tracks .....	53		
Zoom .....	53		
Repeat .....	53		
File List Function .....	53		
<b>Setup Menu</b> .....	<b>54</b>		
Main Page .....	54		
<b>MENU ITEMS</b> .....	<b>54</b>		
VIDEO SETUP PAGE .....	54		
LANGUAGE SETUP .....	54		
PREFERENCES .....	54		

# DVD

## HOW TO WATCH A DVD

When TV set is turned on, press **DVD button** on Remote Control and press play, or directly press play button at the front panel. If there is no disc inside of the loader, press Open / Close button, place a DVD and press play.

## General Properties

- DVD / VCD / CD / CD-R / CD-RW / MP3 / JPEG / MPEG playback.
- PAL playback (according to disc content)
- User-friendly multilanguage OSD menu control.
-  LPCM audio via coaxial and optical digital audio outputs. (optional)
- Multiple Aspect Ratio support (16:9 Widescreen, 4:3 Letterbox, 4:3 PAN & SCAN)
- Multi-Audio (up to 8) support (According to disc content)
- Multi-Subtitle (up to 32) support (According to disc content)
- Multi-Angle (up to 9) support (According to disc content)
- 8 level parental control
- Fast forward and rewind in 5 different speeds. (2x, 4x, 8x, 16x, 32x)
- Slow motion playback in 4 different speeds. (1/2x, 1/4x, 1/8x, 1/16x forward)
- Frame by frame forward playback.
- Time Search
- Repeat
- A → B repeat
- Program function for Audio CD, MP3 and JPEG.
- Coaxial & Optical digital audio outputs (optional)
- Copied disks may be incompatible.

### Note:

\*\*\* This DVD player may not support some MP3 recordings due to differences in recording formats or disc type.

\*\*\* Please read the owner's manual about MP3 playback.

\*\*\* CD-R/CD-RW discs recorded by CD-DA method can be played. Some CD-R/CD-RW discs may be incompatible due to laser pick-up and disc design.

\*\*\* Some VCD/SVCD discs may be incompatible.

\*\*\* DVD-R/RW discs recorded by DVD-Video method can be played. Some DVD-R/RW discs

may be incompatible due to laser pick-up and disc design.

\*\*\* Some discs may be incompatible with JPEG Viewer function due to different recording format or condition of the discs.

## About this Manual

### Safety Information

#### CAUTION

DVD Player is a class 1 laser product. However this product uses a visible laser beam which could cause hazardous radiation exposure. Be sure to operate the player correctly as instructed.

## CLASS 1 LASER PRODUCT

- Manufactured under license from Dolby Laboratories. "Dolby", and the double-D symbol are trademarks of Dolby Laboratories.
- DTS and DTS Digital Out are trademarks of Digital Theater Systems, Inc.

## CAUTION

### RISK OF ELECTRIC SHOCK



The lightning flash with arrowhead symbol, within an equilateral triangle, is intended to alert the user to the presence of uninsulated "dangerous voltage" within the product's enclosure that may be of sufficient magnitude to constitute a risk of electric shock of persons.



The exclamation point within an equilateral triangle is intended to alert the user to the presence of important operating and maintenance (servicing)

instructions in the literature accompanying the appliance.

### Notes on Discs

#### On handling discs

- To keep the disc clean, handle the disc by its edge. Do not touch the surface.
- Do not stick paper or tape on the disc.
- If the disc is contaminated with any substance like glue remove before using it.

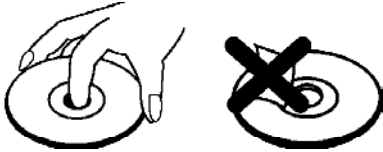

- Do not expose the disc to direct sunlight or heat sources such as hot air ducts, or leave it in a car parked in direct sunlight as the tem-

### HOW TO WATCH A DVD

When TV set is turned on, press **DVD button** on Remote Control and press play, or directly press play button at the front panel. If there is no disc inside the tray, press Open / Close button, place a DVD and press play.

perature can rise quickly and damage the disc.

- After playing, store the disc in its case.

#### On cleaning

- Before playing, clean the disc with a cleaning cloth. Wipe the disc from the center out.

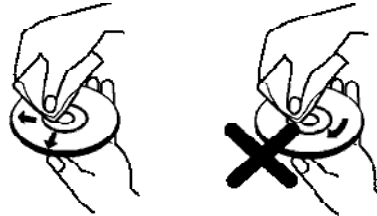

- Do not use solvents such as benzene, thinner, commercially available cleaners or anti-static spray intended for vinyl LPs.

This product incorporates copyright protection technology that is protected by method claims of certain U.S. patents and other intellectual property rights owned by Macrovision Corporation and other rights owners. Use of this copyright protection technology must be authorized by Macrovision Corporation, and is intended for home and other limited viewing uses only unless otherwise authorized by Macrovision Corporation. Reverse engineering or disassembly is prohibited.

### DVD Control Panel Buttons

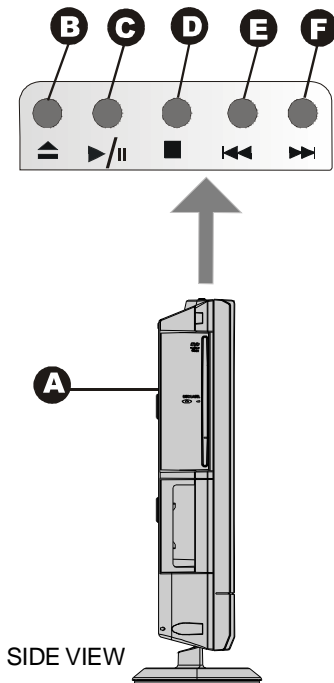

**A** Disc Tray Loader = Please insert a disc to the disc Loader.

**B** = Open / Close

(Eject or Load the disc)

**C** = Plays/pauses the disc. When DVD menu (root menu) is active, this button functions as "button select" (selects the highlighted item in menu) if this is not prohibited by the disc.

**D** = Stop (Stop playing disc.)

**E** = Search back / Skip back

**F** = Search forward / Skip next

*Note 1: 8 cm discs should be placed into the tray in accordance with the indication marks.*

*Note 2: Search forward and search back function will be available when you constantly press or button.*

## Remote Control Buttons

## DVD MODE

- ① Standby On-Of
- ② Digits (Press to enter track/chapter/title/time/etc... numbers directly.)
- ③ To enter 2-digit numbers
- ④ Cursor Up
- ⑤ Cursor Left
- ⑥ Play / Pause
- ⑦ Stop
- ⑧ Search Forward
- ⑨ Search Back
- ⑩ Zooms the picture by 2x, 3x, 4x while playing DVD/VCD/SVCD. Pressing zoom button again disables zoom mode.
- ⑪ Press to enter file list mode to list all the files in the disc. In file list mode, the same type of files can be played back together in repeat modes.
- ⑫ Press to execute the A↔B repeat play if not prohibited by the disc.
- ⑬ Press to execute disc/title/chapter repeat if not prohibited by the disc.
- ⑭ Displays the content menu during playback or displays the set-up menu during "Stop & Resume" mode.
- ⑮ Eject/Load
- ⑯ Displays the title menu of the DVD if supported by the disc or changes the status of PBC functionality for VCD and SVCD.
- ⑰ Clear
- ⑱ Press to select the unit for search (title, chapter, track, index, time etc.) if not prohibited by the disc.
- ⑲ Changes the playing time display mode of the disc, title, track etc., on the OSD.
- ⑳ Skip Next
- ㉑ Skip Back
- ㉒ No Function
- ㉓ DVD MENU
- ㉔ Volume Down
- ㉕ Volume Up
- ㉖ Cursor Down
- ㉗ Cursor Right
- ㉘ Executes the items or settings.
- ㉙ Changes the angles when playing a DVD if supported by the disc.
- ㉚ TV MENU
- ㉛ Changes the language of the sound while playing a DVD if supported by the disc.
- ㉜ Changes the language of the subtitle while playing a DVD if supported by the disc.
- ㉝ Returns to root menu or resumes playback from root menu.
- ㉞ **DVD Mode Select**
- ㉟  = Mute

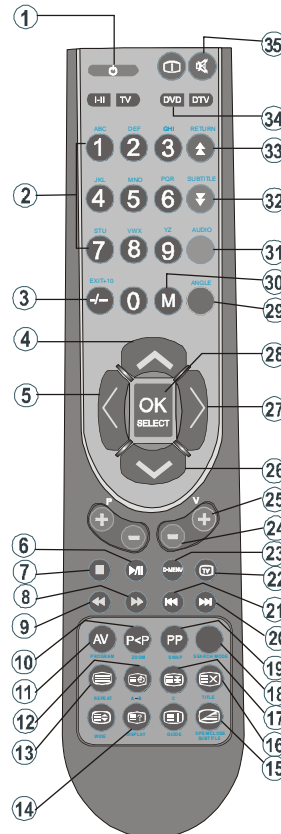

### Disc Types Compatible with This Unit:

This player can play the following discs.

Disc Types (Logos)	Recording Types	Disc Size	Max. Playing Time	Characteristics
<b>DVD</b> 	Audio + Video	12 cm	Single - sided; 240 min. Double - sided; 480 min.	<ul style="list-style-type: none"> <li>• DVD contains excellent sound and video due to Dolby Digital and MPEG-2 System.</li> <li>• Various screen and audio functions can be easily selected through the on screen menu.</li> </ul>
		8 cm	Single - sided; 80 min. Double - sided; 160 min.	
<b>VIDEO-CD</b> 	Audio + Video	12 cm	74 min.	<ul style="list-style-type: none"> <li>• Video with CD sound, VHS quality &amp; MPEG-1 compression technology.</li> </ul>
		8 cm	20 min.	
<b>AUDIO-CD</b> 	Audio	12 cm	74 min.	<ul style="list-style-type: none"> <li>• An LP is recorded as an analog signal with more distortion. CD is recorded as a Digital Signal with better audio quality, less distortion and less deterioration of audio quality over time.</li> </ul>
		8 cm	20 min.	
<b>MP3-CD</b> 	Audio (xxxx.mp3)	12 cm	It depends on MP3 quality.	<ul style="list-style-type: none"> <li>• MP3 is recorded as a Digital Signal with better audio quality, less distortion and less deterioration of audio quality over time.</li> </ul>
		8 cm		
<b>PICTURE-CD</b> 	Video (still picture)	12 cm	It depends on JPEG quality.	<ul style="list-style-type: none"> <li>• JPEG is recorded as a Digital Signal with better picture quality over time.</li> </ul>
		8 cm		
<b>SVCD</b> 	Audio + Video	12 cm	35 min.	<ul style="list-style-type: none"> <li>• SVCD stands for "Super Video CD". A SVCD is very similar to a VCD. It is encoded by MPEG-2 and it has higher video quality than VCD.</li> </ul>
		8 cm	10 min.	

## DVD Playback

### Basic Play

1. Press on the power button
2. Please insert a disc to the loader.

The disc will be automatically loaded and play commences if the disc does not have any menus recorded on it.

A menu may appear on the TV screen after a few moments or the film may start immediately after the introduction of the Film Company. This behaviour depends on the disc content and may change.

**NOTE:** Step 3 and 4 is available only when a menu is recorded on the disc.

**3. Press ◀/▶/▼/▲ or the number button(s) to select the preferred title.**

**4. Press SELECT.**

Play of the selected items now starts. The played item may be a motion picture, a still picture or another submenu depending on the disc.

### For your reference:

- If an action corresponding to a button is prohibited the "⊘" symbol appears.

### Stopping Play

Press stop (■) twice.

To stop the play permanently, press STOP (■) twice. When the STOP (■) button is pressed for the first time, a message "PRESS PLAY KEY TO CONTINUE" will appear on the screen to remind you if you want to continue the play. To stop the play, press the STOP (■) button again or you can press SELECT to continue.

Stopping Play and Returning To The Menu Screen:

(When a menu is available on the disc)

Press MENU or TITLE button depending on the disc. Play is suspended, and the Disc menu screen is displayed.

### Rapid Advance (Rapid Reverse)

Press **SEARCH/SLOW (▶▶)** or **SEARCH/SLOW (◀◀)** on the remote control during play.

- Normal play is resumed when the **SELECT** button or **PLAY/PAUSE (▶/||)** button is pressed.
- The speed of advance (▶▶ 2x, ▶▶ 4x, ▶▶ 8x, ▶▶ 16x, ▶▶ 32x) or reverse (◀◀ 2x, ◀◀ 4x, ◀◀ 8x, ◀◀ 16x, ◀◀ 32x) changes for every press of the ▶▶ or ◀◀ button.

**Note:** No sound will be heard during Rapid advance or Rapid reverse.

## Skipping Ahead or Back to Chapters

### Skipping ahead

Press **SKIP/ FRAME (▶▶|)** on the remote control during play.

A chapter is skipped forward each time the button is pressed.

### Skipping back

Press **SKIP/ FRAME (|◀◀)** on the remote control during play.

When the button is pressed once midway through a chapter, play returns to the previous chapter.

### Still Picture (PAUSE)

Press **PLAY/PAUSE (▶/||)** once during play.

The screen freezes.

To return to normal play press **PLAY/PAUSE (▶/||)** again.

### Frame Advance (STEP FORWARD)

Press **PLAY/PAUSE (▶/||)** once during play.

The screen freezes.

Press **SKIP/ FRAME (▶▶|)** on the remote control.

The next frame of the movie is displayed.

You can press **SKIP/ FRAME (▶▶|)** for the following frames.

To return to normal play press **PLAY/PAUSE (▶/||)** again.

**NOTE: Reverse stepping is not available.**

### Slow-motion Play Forward

Press **PLAY/PAUSE (▶/||)** once during play.

The screen freezes.

Press **SEARCH/SLOW (▶▶)** on the remote control.

The unit starts playing the movie at four different speeds (▶▶ 1/2, ▶▶ 1/4, ▶▶ 1/8 and ▶▶ 1/16).

You can increase or decrease the speed of the slow-motion play by pressing **SEARCH/SLOW (▶▶ or ◀◀)**.

The speed of slow motion play is displayed on the screen each time you change it.

To return to normal play, press **PLAY/PAUSE (▶/||)**.

**NOTE:** No sound will be heard during Slow motion play.

**NOTE:** Reverse slow motion play is not available.

### Direct Selection of Scenes

### Selecting Scenes by Chapter Number

**Press SEARCH on the remote control once during playback.**

The chapter/title search box is displayed on the screen. You can see the currently playing and total number of chapters in right hand side of the display bar as -- / xx.

**Enter the number of the chapter using number buttons.**

The selected chapter is played just after you enter the chapter number.

**For your convenience:**

- If the chapter number you entered is between 0 and 9, player will automatically jump to the related chapter. To enter a chapter number which is more than 1 digit, press **+10** key and then enter the chapter number.
- You can clear the field by pressing the **C** button if you enter a wrong number.
- If you attempt to enter a number greater than the total number of chapters on the current title, the search box disappears and "Input Invalid" message is displayed on screen.
- If you wait five seconds without pressing any key for selecting scenes by chapter number, the operation is cancelled.
- You can press RETURN key to cancel title search.

**Selecting Scenes by Title Number**

**Press SEARCH on the remote control once during playback.**

The chapter/title search box is displayed on the screen. You can see the currently playing and total number of titles in left hand side of the display bar as -- / xx.

**Press ◀ (Left) or ▶ (Right) button on the remote control to select the title field in the search box to change the title.**

You can see the currently playing title and total title numbers on the top-left side of the display as -- / xx.

**Enter the number of the title using number buttons.**

The selected title is played just after you enter the title number.

**Selecting Scenes by Time**

You can view the DVD starting from any time point you want.

**Press SEARCH on the remote control "twice" during playback.**

The time search box is displayed on the screen as **Title xx/xx Time -- : -- : --**.

Enter the time using number buttons.

The title is played beginning from the desired time just after you enter the time. If not prohibited by the DVD.

**Press SEARCH on the remote control "three times" during playback.**

The time search box is displayed on the screen as **Chapter xx/xx Time -- : -- : --**.

Enter the time using number buttons.

The Chapter is played beginning from the desired time just after you enter the time. If not prohibited by the DVD.

**For your convenience:**

- You can clear the fields by pressing the **C** button if you enter wrong numbers.
- If you attempt to enter a number greater than the total time of the current title, the time search box disappears, "Input Invalid" message is displayed on screen.
- If you wait five seconds without pressing any key to enter time, selecting scenes by time option is cancelled.
- You can press RETURN key to cancel time search.

**Repeat Play**

**Repeat Viewing**

Press REPEAT during play.

Each time this button is pressed, a different repeat box is displayed on the screen.

- If "CHAPTER" is displayed, the current chapter will be played again.
- If "TITLE" is displayed, the current title will be played again.
- If "ALL" is displayed, all titles and chapters will be played again.

**NOTE:** Repeat play may be prohibited by some DVD titles.

**Repeating two specific points between sections. (A – B repeat)**

**Press A-B during play at the point where repeat play is to commence (A).**

"A" is displayed.

**Press A-B again at the point where repeat play is to be concluded (B).**

"AB" is displayed and the repeat play of the selection between points A and B starts, if not prohibited by the DVD.

To return to normal play

Press **A-B** again.

**Convenient Functions**

**Displaying the time information**

**Press DISPLAY during play.**

Some information is displayed on TV screen to indicate the current status of the disc. On the display screen you can find the following information lines:

**Line 1:** Time Counter Mode

**Line 2:** Title Number, Chapter Number, Time Counter

**Line 3:** Audio Number, Audio Format, Number of Output Channels, Audio Language

**Line 4:** Subtitle Number & Subtitle Language

Time counter modes can be selected by pressing **TIME** key consecutively.

The sequence for time counter modes is as follows: TITLE ELAPSED, TITLE REMAIN, CHAPTER ELAPSED and CHAPTER REMAIN.



- If "TITLE ELAPSED" is displayed, the elapsed time for the title is being displayed.
- If "TITLE REMAIN" is displayed the remaining time for the title is being displayed.
- If "CHAPTER ELAPSED" is displayed, the elapsed time for the chapter is being displayed.
- If "CHAPTER REMAIN" is displayed, the remaining time for the chapter is being displayed.



Pressing the **TIME** key for the fifth time closes display menu screen. "DISPLAY OFF" is displayed.

#### **Displaying a scene with a larger and closer view**

The 'zoom in' function enables you to take a closer look at the scene you are viewing that is especially an impressive function when you are seeing science fiction or adventure film.

Press **ZOOM** during play.

" 2X" is displayed on the screen and the picture is now larger. By pressing **ZOOM** key consecutively you can reach "" 3X", "" 4X" modes.

**NOTE:** You can move in the picture, i.e. change the zoomed location, by using the < (Left) / > (Right) /  (Down) /  (Up) arrow keys.

To return to normal play

Press **ZOOM** again.

#### **Displaying / Changing Subtitle Language**

It is possible to change the subtitle language from the one selected at the initial settings to a different language, if available.

(This operation works only with discs on which multiple subtitle languages are recorded.)

Press **SUBTITLE** during play.

When no subtitles are recorded " " will be displayed instead of the selected language.

#### **Press SUBTITLE a number of times until the preferred language is selected.**

When this button is pressed once, the first subtitle recorded on the disc will display. The rest of the subtitles recorded will display in sequence for every press of the **SUBTITLE** button.

**NOTE:**

- In some cases, the subtitle language is not changed immediately to the selected one.

For your convenience:

- When the preferred language is not selected even after pressing the button several times, it means that the language is not available on the disc.
- When the player is restarted or the disc is changed, the subtitle selection is automatically changed back to the initial settings.
- If a language is selected, which is not supported by the disc, the subtitle language will automatically be set to the disc's priority language.
- Usually a circulation will happen while switching to another language, that is you can cancel the subtitle by pressing this button a number of times until "Subtitle Off " appears on the screen.

#### **Changing Audio Soundtrack Language**

It is possible to change the audio language from the one selected at the initial settings to a different language, if available.

(This operation works only with discs on which multiple audio soundtrack languages are recorded, if not prohibited by the DVD.)

Press **AUDIO** during play.

#### **Press AUDIO a number of times until the preferred language is selected.**

For your convenience:

- When the preferred language is not selected even after pressing the button several times, it means that the language is not available on the disc.
- When the power is turned on or the disc is removed, the language heard is the one selected at the initial settings. If this language is not recorded on the disc, only the available language on the disc will be heard.

#### **Viewing From Another Angle**

Some DVD discs may contain scenes, which have been shot simultaneously from a number of different angles. For these discs, the same scenes can be viewed from each of these different angles using the **ANGLE** button.

The number of recorded angles differs depending on the disc used.

“ **y/x** ” is displayed shortly on the screen during playback. This indicates that the multi-angle scene has just started. From that moment on, the **y**<sup>th</sup> angle of total **x** angles is played and you can change the viewing angle until the end of the multi-angle scene.

- In **SETUP** menu, an ‘ANGLE MARK’ option exists, which, if enabled, will display a continuous angle mark on the screen as long as multi-angle scene is available.

Press **ANGLE** during play.

The current angle is changed.

**Press ANGLE a number of times until the preferred viewing angle is selected.**

- This function will only work on discs where different angles have been recorded.

### Using a DVD Menu





Some DVD discs have unique menu structures called DVD menus. For example, DVDs programmed with complex contents provide guide menus, and those recorded with various languages provide menus for audio and subtitle language. Although the DVD menus’ contents and operation differ from disc to disc, the following explains basic operation when this feature is used.

**Press TITLE or MENU on the remote control.**

The DVD menu available on the disc is now displayed.

NOTE:

- If you press **MENU**, the root menu of DVD is displayed.
- If you press **TITLE**, the menu of the current title is displayed.

**Press  /  /  /  to select the preferred item.**

Press **SELECT**.

The selected item is now executed.

For your convenience:

- You can also use **number** keys to select a DVD menu item. The player will automatically execute the item. To enter an item number which is more than 1 digit, press **+10** key and then enter the item number.

NOTE:

- Some DVDs may not contain root and/or title menus.
- To resume the playback, select **PLAY** item in DVD menu.

## Video CD Playback

### Basic Play





1. Please insert a disc to the loader.
- For Video CDs without playback control:
2. The disc loaded and play commences.
- For Video CDs provided with playback control:  
A menu screen will appear on the screen after a few moments.
3. Menu Play
- This function works only with video CDs with playback control (version 2.0). Follow the instructions on the menu screen for interactive operations.
  - The details differ depending on the disc concerned. Also refer to the instructions accompanying the disc.

After steps 1 to 3 above, the menus are displayed on the TV screen.

4. Press the number button(s) to select the preferred item.

The player now starts to play the selected item.

NOTE:

- Use **+10** button to enter two-digit-numbers.
-  /  /  /  arrow buttons are not used for selecting items for video CDs.





### What is playback control?

If a video CD has “playback control” written on the jacket of disc, it means that particular scenes or information can be selected for viewing interactive with TV screen using the menu screen.

NOTE:

- **TITLE** button is dedicated to PBC “playback control” during VCD playback. You can change PBC mode with **TITLE** button.
- For using Repeat Modes you need to switch off PBC manually.
- If you use Search mode, PBC automatically switches to OFF.
- PBC ON is default. Whenever you eject the CD it will be ON.

Stopping play

- To stop the play permanently, press **STOP** () twice. When the **STOP** () button is pressed for the first time, a message “Press Play Key To Continue” will appear on the screen to remind you if you want to continue the play. To stop the play, press the **STOP** () button again or you can press **PLAY / PAUSE** () to continue.

### Rapid Advance / Rapid Reverse

Press SEARCH/SLOW (▶▶ or ◀◀) on the remote control during play.

- Normal play is resumed when the **SELECT** button or **PLAY/PAUSE** (▶/||) button is pressed.
- The speed of advance (▶▶ 2x, ▶▶ 4x, ▶▶ 8x, ▶▶ 16x, ▶▶ 32x) or reverse (◀◀ 2x, ◀◀ 4x, ◀◀ 8x, ◀◀ 16x, ◀◀ 32x) changes for every press of the ▶▶ or ◀◀ button.

**Note:** No sound will be heard during Rapid advance or Rapid reverse.

### Skipping Ahead or Back to Chapters

#### Skipping ahead

Press SKIP/ FRAME (▶▶) on the remote control during play.

A track is skipped each time the button is pressed.

#### Skipping back

Press SKIP/ FRAME (◀◀) on the remote control during play.

When the button is pressed once midway through a track, play returns to the start of previous track. When it is pressed again, a track is skipped.

#### Still Picture (PAUSE)

Press PLAY/PAUSE (▶/||) once during play.

The screen freezes.

To return to normal play press PLAY/PAUSE (▶/||) again.

#### Frame Advance (STEP Forward)

Press PLAY/PAUSE (▶/||) once during play.

The screen freezes.

Press SKIP/ FRAME (▶▶) on the remote control.

The next frame of the movie is displayed.

You can press SKIP/ FRAME (▶▶) for the following frames.

**NOTE:** Reverse stepping is not available.

#### Slow-motion Play

Press PLAY/PAUSE (▶/||) once during play.

The screen freezes.

Press SEARCH/SLOW (▶▶) on the remote control.

You can increase or decrease the speed of the slow-motion play by pressing SEARCH/SLOW (▶▶ or ◀◀). There are 4 slow motion modes as ▶▶ 1/16, ▶▶ 1/8, ▶▶ 1/4, ▶▶ 1/2.

The speed of slow motion play is displayed on the screen each time you change it.

To return to normal play press PLAY/PAUSE (▶/||) again.

**NOTE:** No sound will be heard during Slow motion play.

**NOTE:** Reverse slow motion play is not available.

### Direct Selection of Scenes

#### Selecting Scenes by Time

You can view the video CD, starting from any time point you want.

Press SEARCH on the remote control once time during playback.

The time search box is displayed on the screen as SELECT TRACK : \_ \_ / xx

Player goes to entered track of the disc.

Press SEARCH on the remote control two times during playback.

The time search box is displayed on the screen as DISC GOTO: \_ : \_ \_ : \_ \_

Player goes to entered time of the disc.

Press SEARCH on the remote control three times during playback.

The time search box is displayed on the screen as TRACK GOTO: \_ : \_ \_ : \_ \_

Player goes to entered time of the current track.

Enter the time using number buttons.

The title is played beginning from the desired time just after you enter the time.

For your convenience:

- If you attempt to enter a number greater than the total time of the current title, the time search box disappears and "⊗ Input Invalid" message appears on up-left corner of screen.
- If you give up entering the time simply press RETURN button, and the operation is cancelled.

#### Accessing tracks using number buttons:

You can play any track you want, just by pressing the corresponding number button.

**For the track numbers which are greater than "9" use +10 button. Press this button once and then type the two digit track number.**



If you attempt to enter a number greater than the total number of tracks on disc, "⊗" message is displayed on the screen.

#### Repeat Play

##### Repeat Viewing

Press REPEAT during play.

Each time this button is pressed, a different repeat box is displayed on the screen.

- If “ All” is displayed, the whole disc will be played again.
- If “ Track” is displayed, the current track will be played again.

#### Repeating two specific points between sections. (A –B repeat)

Press A-B during play at the point where repeat play is to commence (A).

“ A” is displayed on screen.

Press A-B again at the point where repeat play is to be concluded (B).

“ AB” is displayed and the repeat-play of the selection between points A and B starts.

To return to normal play

Press **A-B** again. A-B Repeat is disabled.

#### Convenient Functions

Displaying the time information

Press TIME during play.

Each time this button is pressed, a different time information box is displayed on the screen.

- If “Single elapsed” is displayed, the elapsed time for the title which is being played will be displayed.
- If “Single remain” is displayed, the remaining time for the title which is being played will be displayed.

**NOTE:** If PBC feature is set to OFF then two other time information modes are also available which are “Total elapsed” and “Total remain”.



- If “Total Elapsed” is displayed, the elapsed time for the disc is being displayed.
- If “Total remain” is displayed, the remaining time for the disc is being displayed.

Pressing the TIME key again closes display menu screen. “DISPLAY OFF” is displayed.

#### Displaying a scene with a larger and closer view

This ‘zoom-in’ function enables you to take a closer look at the scene you are viewing. This is especially an impressive function when you are watching science fiction or adventure film.

Press ZOOM during play.

“ 2X” is displayed on the screen and the picture is now larger. By pressing **ZOOM** key consecutively you can reach “ 3X”, “ 4X” modes.

**NOTE:** You can move in the picture, i.e. change the zoomed location, by using the **◀ (Left) / ▶ (Right) / ▼ (Down) / ▲(Up)** arrow keys.

To return to normal play;

Press ZOOM again.

## CD Menu

CD Menu is used to display the directory structure of data discs which would contain files such as JPEG/MPEG/MP3 and to display the tracks of Audio CDs.

### Basic Play

1. Please insert a CD-R disc to the loader.

“Loading” message appears on screen. Please wait for a moment.

CD MENU appears. Directories and the files in the root directory are listed. (For Audio CD, the tracks are listed.)

2. Press **▼ / ▲** to select files or directories.

In the stop mode or while playing MP3 the user can navigate in the current directory.

3. Press SELECT, **◀ / ▶** to switch between directories & files.

If a directory is selected and SELECT or “**▶**” key is pressed then the selected directory content is displayed after reading directory.

To switch from a sub directory to an upper directory, press SELECT or “**▶**” key while the top-most option in the directory (“...”) is selected or press “**◀**”.

4. Press SELECT on a file to play.

### MP3/MPEG File :

Selected MP3 / MPEG starts to play.

Elapsed or Remaining Time can be displayed using DISPLAY key and can be changed using TIME key.

### JPEG File :

Selected JPEG is displayed in full screen and Slide Show starts automatically.

### Audio CD Track:

Elapsed or Remaining Time can be displayed using DISPLAY key and can be changed using TIME key.

### Pause

Press PLAY/PAUSE (**▶/||**) once during play.

The play freezes.

PAUSE message appears on screen.

To return to normal play press PLAY/PAUSE (**▶/||**) again.

### Stopping Play

Press STOP (**■**).

The play is stopped.

**NOTE:** If a JPEG file is displayed, pressing MENU also stops the play.

**MP3/MPEG:** CD MENU is displayed.

## Rapid Advance ( Rapid Reverse)

### MP3/MPEG Track:

Press SEARCH/SLOW (◀◀ or ▶▶) during play to decrease/increase play speed.

◀◀ 32x, ◀◀ 16x, ◀◀ 8x, ◀◀ 4x, ◀◀ 2x, PLAY, ▶▶ 2x, ▶▶ 4x, ▶▶ 8x, ▶▶ 16x, ▶▶ 32x are the play speed modes.

### Skipping Ahead or Back to Tracks

Press SKIP/ FRAME (◀◀◀ / ▶▶▶) during play to jump to the previous/next file.



Next file in the current directory will be played. Press SKIP/ FRAME (◀◀◀ / ▶▶▶) during stop mode to jump to the previous/next page of the current directory.

### Zoom

MPEG:

This "zoom in" function enables you to take a closer look at the scene you are viewing that is especially an impressive function when you are seeing science fiction or adventure film.

Press ZOOM during play.

" 2X" is displayed on the screen and the picture is now larger. By pressing ZOOM key consecutively you can reach " 3X", " 4X" modes.

**NOTE:** You can move in the picture, i.e. change the zoomed location, by using the ◀ (Left) / ▶ (Right) / ▼ (Down) / ▲ (Up) arrow keys.

To return to normal play;

Press ZOOM again.

JPEG :

Press PLAY (▶) to start slide show.

It is provided both ZOOM in/out and Zoom pan functions for JPEG pictures.

Press ZOOM to turn on/off this function.

When this mode is on, a message will indicate the current ratio on screen.

If zoom mode is on,

Press ▶▶ / ◀◀ to control the ratio of zoom in/out.

The zoom ratios are %50 and %75 for zoom out and %100, %125, %150 and %200 for zoom in. (The order is: %50, %75, %100, %125, %150, %200)(The initial ratio is %100)

With ZOOM mode off, a picture is scaled to fit the whole screen.

Note:

- Slide Show is disabled when the ZOOM mode is on.

## Repeat

### Press REPEAT to change current repeat mode.

In CD MENU it is displayed at the bottom.

The options available are:

**FOLDER:** When this mode is selected, the current folder will be played once.

**SINGLE:** When this mode is selected, the current track will be played once.

**REPEAT ONE:** When this mode is selected, the current track will be repeated continuously.

**REPEAT FOLDER:** When this mode is selected, the current folder will be repeated continuously.

### Repeating two specific points between sections. (A –B repeat)

#### MP3, Audio CD Track:

Press A-B during play at the point where repeat play is to commence (A).

" A" is displayed on screen.

Press A-B again at the point where repeat play is to be concluded (B).

" AB" is displayed and the repeat-play of the selection between points A and B starts.

To return to normal play

Press A-B again. A-B Repeat is disabled.

#### Display Function

Press TIME to change displayed time mode.

There are two time modes :

- Single Elapsed
- Single Remain

Time is displayed during MP3,MPEG and Audio CD track playback.

#### File List Function

Press PROG to select file list mode

All the files in the disc are listed.

The same types of files in the list are played together sequentially.

If a MP3 file is selected to play then all the MP3 files in the list are played sequentially.

If a MPEG file is selected to play then all the MPEG files in the list are played sequentially.

If a JPEG file is selected to display then all the JPEG files in the list are displayed sequentially.

To stop the playback of the files:

If a MP3/MPEG file is played; press **STOP (■)**.

If a JPEG file is displayed; press MENU or **STOP (■)**.

Press **PROG** to quit file list mode.

## Setup Menu

Press DISPLAY key on the remote control when the player is not in playback mode.

The setup menu-main page appears. To close the setup menu, press DISPLAY key.

### Main Page

**In the main page, the first page is selected by default.**

Select pages using ◀ / ▶ arrow buttons.

When selected, the page will be highlighted and the items of the selected page will be displayed.

Press SELECT or ▼ arrow button to enter selected page.

When entered a page, the first item of the page is selected and the sub-items of that item are listed on the right.

**NOTE:** To return to main page, press ◀ arrow button. To close the setup menu, press DISPLAY key.

### Using Pages

When entered a page, the first item of the page is selected by default and the sub-items of the selected item are listed on the right.

Use ▼ / ▲ arrow buttons to change the selected item in the page.

The sub-items of the selected item are listed on the right.

Press SELECT or ▶ arrow button to select the sub-items of the selected item.

**The sub-item is selected on the right menu.**

Use ▼ / ▲ arrow buttons to change the selected sub-item.

Press SELECT to choose the selected sub-item on the right menu.

## MENU ITEMS

### VIDEO SETUP PAGE

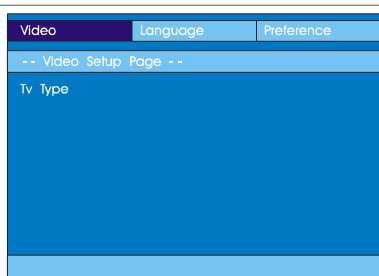

#### TV TYPE:

TV Type is only available as 'PAL'.

## LANGUAGE SETUP



#### OSD LANG:

You can select the default OSD language of the player menus

#### AUDIO:

You can select the default audio language if supported by the DVD disc.

#### DISC MENU:

You can select the DVD's disc menu language among these languages. Disc menu appears in the selected language, if supported by the DVD disc.

#### SUBTITLE:

You can select the default subtitle language if supported by the DVD disc.

## PREFERENCES

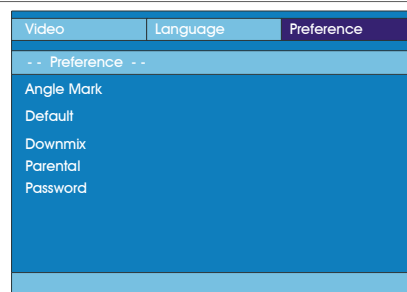

#### ANGLE MARK:

This option allows you to turn on /off the angle mark on the screen, which is displayed to indicate that a multi angle scene has started. It also shows which angle you are currently watching.

#### DEFAULT:

If you choose RESET and press SELECT, the factory-presets are loaded. Parental level and parental password does not change.

#### DOWNMIX:

This mode can be selected when the digital audio output of the TV is used.

SURROUND: Surround sound output.

STEREO: Two channels stereo.

### PARENTAL (Parental Level):

Video	Language	Preference
-- Preference --		
Angle Mark	1	G
Standby Time	2	
Default	3	Pg
Downmix	4	Pg 13
Parental	5	
Password	6	PG -R
	7	Nc 12
	8	Adult

Playing some DVDs can be limited depending on the age of users. The "Parental Control" function allows playback limitation level to be set by the parent.

Parental Level can be adjusted to one of the eight levels. Level "8 ADULT" adjustment let you watch all of the DVD titles ignoring the DVD disc's parental level. You can watch the DVD discs, which has the same or lower parental level than the player's level only.

#### PASSWORD (Change Password):

Using this item you can change the current password.

To change the password you will be prompted to enter your old password. After you have entered your old password, you can now enter the new 4-digit password.

You can use **C** key to delete the incorrect entry.

**Note:** Factory preset of the password is "0000". You have to enter XXXX digital password every time you want to change the parental level. If you forget your password please contact technical service.

### Troubleshooting

#### The picture quality is poor (DVD)

- Make sure the DVD disc surface is not damaged. (Scratch, fingerprint etc.)
- Clean the DVD disc and try again.
  - See instructions described in "Notes on Discs" to clean your disc properly.
- Ensure that the DVD disc is in the drawer with the label uppermost.
- A damp DVD disc or condensation may effect the equipment. Wait for 1 to 2 hours in Standby to dry the equipment.

#### Disc does not play

- No disc in the machine.

- Place a disc onto the tray.
- Disc incorrectly loaded.
  - Ensure that the DVD disc is in the drawer with the label uppermost.
- Wrong type of disc. The machine cannot play CD-ROMS etc.
- The region code of the DVD must match the player.

#### Wrong OSD language

- Select the language in the set-up menu. The language for the sound or subtitles on a DVD cannot be changed.

- Multilingual sound and/or subtitles not recorded on the DVD.

- Try to change the sound or subtitles using DVD's title menu. Some DVD's do not allow the user to change these settings without using the disc's menu

#### Some functions (Angle, Zoom etc) do not work

- These functions are not available on the DVD.
- Angle can only be changed when the angle symbol is displayed.

#### No picture

- Have you pressed the correct buttons on the remote control? Try once more.

#### No sound

- Check the volume is set to an audible level.
- Make sure you have not switched the sound off accidentally.

#### Distorted sound

- Check that the appropriate listening mode setting is correct.

#### No response from remote control

- Make sure the remote control is in the correct mode.
- Check batteries are fitted correctly.
- Change the batteries.

#### If nothing works

If you have tried the above solutions and none seem to work, try switching your TV-DVD off and on again. If this does not work, contact your supplier or TV-DVD repair technician. **Never attempt to repair a defective TV-DVD yourself.**

## Definition of Terms

### Angle

Recorded onto some DVD discs are scenes, which have been simultaneously shot from a number of different angles (the same scene is shot from the front, from the left side, from the right side, etc.). With such discs, the ANGLE button can be used to view the scene from different angles.

### Chapter Number

These numbers are recorded on DVD discs. A title is subdivided into many sections, each of which are numbered, and specific parts of video presentations can be searched quickly using these numbers.

### DVD

This refers to a high-density optical disc on which high-quality pictures and sound have been recorded by means of digital signals. Incorporating a new video compression technology (MPEG II) and high-density recording technology, DVD enables aesthetically pleasing full-motion video to be recorded over long periods of time (for instance, a whole movie can be recorded).

DVD has a structure consisting of two 0.6-mm thin discs, which are adhered to each other. Since the thinner the disc, the higher the density at which the information can be recorded, a DVD disc has a greater capacity than a single 1.2 mm thick disc. Since the two thin discs are adhered to each other, there is the potential to achieve double-sided play sometime in the future for even longer duration play.

### Playback Control

This is recorded on a Video CD (Version 2.0). The scenes or information to be viewed (or listened to) can be selected interactively with the TV monitor by looking at the menu shown on the TV monitor.

### Subtitles

These are printed lines appearing at the bottom of the screen, which translate or transcribe the dialogue. They are recorded on the DVD discs.

### Time Number

This indicates the playtime, which has elapsed from the start of a disc or a title. It can be used to find a specific scene quickly. (Not all discs permit the time search feature to be used. Availability is determined by the disc's manufacturer.)

### Title Number

These numbers are recorded on DVD discs. When a disc contains two or more movies, these movies are numbered as title 1, title 2, etc.

### Track Number

These numbers are assigned to the tracks, which are recorded on AudioCDs. They enable specific tracks to be located quickly.

### Video CD

This contains recordings of pictures and sound whose quality is on a par with that of videotape. This player also supports Video CDs with playback control (Version 2.0).

### Dolby Digital

Many movie theatres are equipped with 5.1 channel surround systems. This same type of technology is available to you in your home. To enjoy full 5.1-channel surround, your DVD player must be connected to an external Dolby Digital decoder via the digital outputs (either coaxial or optical).

### Dolby Pro Logic

This is Dolby Laboratories' technology to decode Dolby Surround encoded programs actively. Dolby Surround programs have four channels of audio (Left, Center, Right and Surround) encoded into a standard 2-channel stereo signal. The rear channel is monaural.

### LPCM

LPCM stands for Pulse Code Modulation and is digital audio.

### MPEG

Short for Moving Picture Experts Group. This is an international standard for compression of moving images. On some DVDs digital audio has been compressed and recorded in this format.

## Specifications

DVD / VCD / CD / CD-R / CD-RW / MP3 / JPEG / MPEG player,

<b>Types of Discs Supported</b>	<b>DVD:</b> SS/SL 4.7" (DVD-5) SS/DL 4.7" (DVD-9) DS/SL 4.7" (DVD-10) DS/DL 4.7" (DVD-18)  <b>VCD/SVCD</b> <b>CD-DA</b> <b>CD-R</b> <b>CD-RW</b> <b>MP-3/JPEG</b>
<b>Video Type</b>	MPEG-2 Video Standard Decoding (MPEG-1 supported) Full-Screen Video Display of 720 x 576 (PAL) pixels 50 and 60 Hz frame refresh rates (PAL) Digital bit-stream processing rate up to 108Mbits/sec Line resolution more than 500 lines
<b>Audio Type</b>	Dolby Digital Decoding LPCM
<b>Audio Output</b>	<b>Digital Audio Outputs:</b> IEC 958 TOSLINK  <b>Analog Outputs:</b> 24 bit /48, 44.1kHz down-sampling DAC